



WM20-WM30-WM40

**COMMUNICATION
PROTOCOL**

Internal version
rev. 3.0

February 17th, 2016

Index

1	COMMUNICATION PROTOCOL	4
1.1	Introduction	4
1.2	MODBUS functions	4
1.2.1	<i>Function 03h (Read holding registers)</i>	4
1.2.2	<i>Function 04h (Read input registers)</i>	5
1.2.3	<i>Function 06h (Write single holding register)</i>	5
1.2.4	<i>Function 10h (Write multiple register)</i>	6
1.2.5	<i>Function 08h (Diagnostic with sub-function code 00h)</i>	6
1.2.6	<i>Function 14h with sub-function 06h (Reading of record file)</i>	7
1.2.7	<i>Function 42h (Read special registers)</i>	7
1.2.8	<i>Broadcast mode</i>	8
1.3	Application notes	9
1.3.1	<i>General consideration</i>	9
1.3.2	<i>MODBUS timing</i>	9
2	TABLES	10
2.1	Data format representation in Carlo Gavazzi instruments	10
2.1.1	<i>Geometric representation</i>	10
2.1.2	<i>Maximum and minimum electrical values</i>	11
2.2	Firmware version	12
2.3	Carlo Gavazzi Controls identification code	12
2.4	Serial number	12
Note : in WM20 all the letters that make up serial number are upper case even if display shows lower case		
2.5	Instantaneous variables	13
2.6	Maximum variables	14
2.7	Minimum variables	15
2.8	DMD variables	16
2.9	Maximum DMD variables	17
2.10	Total and partial (tariff) energy meters	18
2.11	Harmonic analysis	18
2.11.1	<i>Harmonic phase angles</i>	19
2.12	Modules programming parameter	20
2.12.1	<i>Modules map</i>	20
2.12.2	<i>Base (Module Ref. 1, 2, 3 and 4)</i>	20
2.12.3	<i>RS485 – RS232 (Module Ref. 5 and Module Ref. 6)</i>	25
2.12.4	<i>Ethernet / Bacnet (See 2.12.1 Table: Module Ref. 7, Module Ref. 8 and Module Ref. 18)</i>	27
2.12.5	<i>Analogue output (Module Ref. 9 and Module Ref. 10)</i>	29
2.12.6	<i>Relay / Opto-Mos output (Module Ref. 11 and Module Ref. 12)</i>	30
2.12.7	<i>Digital Inputs and Outputs (Module Ref. 13 and Module Ref. 14)</i>	31
2.12.8	<i>Neutral current direct measurement + Temperature + Process signal measurements (°C/°F) (Module Ref. 16 and 17)</i>	34
2.12.9	<i>Profibus (See 2.12.1 Table: Module Ref. 20)</i>	34
2.12.10	<i>Commands table</i>	37
2.12.11	<i>Status</i>	39
2.12.12	<i>Code Variables List</i>	42
3	DATABASE SYSTEM	44
3.1	Table of “Data Event” file	44
3.2	Table of “Data Load Profiling” file	46



3.3 Table of "Data Base" file.....47

4 REVISIONS 50

4.0 Modifications from Version 2.850

4.1 Modifications from Version 2.950



1 COMMUNICATION PROTOCOL

1.1 Introduction

For a complete description of the MODBUS protocol refer to “Modbus_Application_Protocol_V1_1a.pdf” and “Modbus_Messaging_Implementation_Guide_V1_0a.pdf” documents that can be download from the www.modbus.org web site.

1.2 MODBUS functions

These functions are available on WM20-WM30-WM40:

1. Reading of n “Holding Registers” (code 03h)
2. Reading of n “Input Register” (code 04h)
3. Writing of one “Holding Registers” (code 06h)
4. Writing of multiple register (code 10h)
5. Diagnostic (code 08h with sub-function code 00h)
6. Reading of “record file” (code 14h with sub-code 06h)
7. Reading of n “Special Registers” (code 42h)
8. Broadcast mode (writing instruction on address 00h)

IMPORTANT:

1. In this document the “Modbus address” field is indicated in two ways:
 - a. **“Modicom address”** : it is the “6 digit Modicom” representation with the Modbus function code 04 (Read Input Registers). It is possible to read the same values with the function code 03 (Read Holding Register) substituting the first digit with number “4”.
2. **“Physical address”**: it is the “word address” value included in the communication frame.
3. The functions 03h and 04h have exactly the same effect.
4. The communication parameters must be set according to the configuration of the instrument (refer to the WM20/WM30/WM40 instruction manual)

1.2.1 Function 03h (Read holding registers)

This function code is used to read the contents of a contiguous block of holding registers (word). The request frame specifies the starting register address and the number of registers to be read. It is possible to read maximum 125 registers (word) with a single request.

The register data in the response message are packed as two bytes per register (word), with the binary contents right justified within each byte. For each register, the first byte contains the high order bits (MSB) and the second contains the low order bits (LSB).

Request frame

Description	Length	Value	Note
Physical Address	1 byte	1 to F7 (1 to 247)	
Function code	1 byte	03h	
Starting Address	2 bytes	0000h to FFFFh	Byte order: MSB, LSB
Quantity of Registers (N word)	2 bytes	1 to 7Dh (1 to 125)	Byte order: MSB, LSB
CRC	2 bytes		

Response frame (correct action)

Description	Length	Value	Note
Physical Address	1 byte	1 to F7 (1 to 247)	
Function code	1 byte	03h	
Byte count	1 byte	N word * 2	
Register value	N*2 bytes		Byte order: MSB, LSB
CRC	2 bytes		

Response frame (incorrect action)

Description	Length	Value	Note
Physical Address	1 byte	1 to F7 (1 to 247)	Possible exception : 01h: illegal function 02h: illegal data address 03h: illegal data value 04h: slave device failure
Function code	1 byte	83h	
Exception code	1 byte	01h, 02h, 03h, 04h	
CRC	2 bytes		

1.2.2 Function 04h (Read input registers)

This function code is used to read the contents of a contiguous block of input registers (word). The request frame specifies the starting register address and the number of registers to be read. It is possible to read maximum 125 registers (word) with a single request.

The register data in the response message are packed as two bytes per register (word), with the binary contents right justified within each byte. For each register, the first byte contains the high order bits (MSB) and the second contains the low order bits (LSB).

Request frame

Description	Length	Value	Note
Physical Address	1 byte	1 to F7 (1 to 247)	
Function code	1 byte	04h	
Starting Address	2 bytes	0000h to FFFFh	Byte order: MSB, LSB
Quantity of Registers (N word)	2 bytes	1 to 7Dh (1 to 125)	Byte order: MSB, LSB
CRC	2 bytes		

Response frame (correct action)

Description	Length	Value	Note
Physical Address	1 byte	1 to F7 (1 to 247)	
Function code	1 byte	04h	
Byte count	1 byte	N word * 2	
Register value	N*2 bytes		Byte order: MSB, LSB
CRC	2 bytes		

Response frame (incorrect action)

Description	Length	Value	Note
Physical Address	1 byte	1 to F7 (1 to 247)	Possible exception : 01h: illegal function 02h: illegal data address 03h: illegal data value 04h: slave device failure
Function code	1 byte	84h	
Exception code	1 byte	01h, 02h, 03h, 04h	
CRC	2 bytes		

1.2.3 Function 06h (Write single holding register)

This function code is used to write a single holding register. The request frame specifies the address of the register (word) to be written and its content.

The correct response is an echo of the request, returned after the register contents have been written.

Request frame

Description	Length	Value	Note
Physical Address	1 byte	1 to F7 (1 to 247)	
Function code	1 byte	06h	
Starting Address	2 bytes	0000h to FFFFh	Byte order: MSB, LSB
Register value	2 bytes	0000h to FFFFh	Byte order: MSB, LSB
CRC	2 bytes		

Response frame (correct action)

Description	Length	Value	Note
Physical Address	1 byte	1 to F7 (1 to 247)	
Function code	1 byte	06h	
Starting Address	2 bytes	0000h to FFFFh	
Register value	2 bytes	0000h to FFFFh	Byte order: MSB, LSB
CRC	2 bytes		

Response frame (incorrect action)

Description	Length	Value	Note
Physical Address	1 byte	1 to F7 (1 to 247)	Possible exception : 01h: illegal function
Function code	1 byte	86h	

Exception code	1 byte	01h, 02h, 03h, 04h	02h: illegal data address
CRC	2 bytes		03h: illegal data value 04h: slave device failure

1.2.4 Function 10h (Write multiple register)

This function code is used to write a block of contiguous registers (maximum 120). The requested values to be written are specified in the request data field. Data is packed as two bytes per register.

The correct response returns the function code, starting address, and the quantity of written registers.

Request frame

Description	Length	Value	Note
Physical Address	1 byte	1 to F7 (1 to 247)	
Function code	1 byte	10h	
Starting Address	2 bytes	0000h to FFFFh	Byte order: MSB, LSB
Quantity of Registers (N word)	2 bytes	0001h to 0078h	Byte order: MSB, LSB
Byte count	1 byte	N word * 2	
Register value	N * 2 bytes	value	Byte order: MSB, LSB
CRC	2 bytes		

Response frame (correct action)

Description	Length	Value	Note
Physical Address	1 byte	1 to F7 (1 to 247)	
Function code	1 byte	10h	
Starting Address	2 bytes	0000h to FFFFh	Byte order: MSB, LSB
Quantity of Registers (N word)	2 bytes	0001h to 0078h	Byte order: MSB, LSB
CRC	2 bytes		

Response frame (incorrect action)

Description	Length	Value	Note
Physical Address	1 byte	1 to F7 (1 to 247)	Possible exception: 01h: illegal function 02h: illegal data address 03h: illegal data value 04h: slave device failure
Function code	1 byte	90h	
Exception code	1 byte	01h, 02h, 03h, 04h	
CRC	2 bytes		

For "Profibus Profile Variable" is mandatory that all variables of this type are under the correct range otherwise the device will return a "Response frame (incorrect action)".

1.2.5 Function 08h (Diagnostic with sub-function code 00h)

The MODBUS function code 08h provides a series of tests to check the communication system between a client (Master) device and a server (Slave), or to check various internal error conditions within a server. WM20-WM30-WM40 supports only 0000h sub-function code (Return Query Data). With this sub-function the data passed in the request data field is to be returned (looped back) in the response. The entire response message should be identical to the request.

Request frame

Description	Length	Value	Note
Physical Address	1 byte	1 to F7 (1 to 247)	
Function code	1 byte	08h	
Sub-function	2 bytes	0000h	
Data (N word)	2 bytes	N word * 2	Byte order: MSB, LSB
CRC	2 bytes		

Response frame (correct action)

Description	Length	Value	Note
Physical Address	1 byte	1 to F7 (1 to 247)	
Function code	1 byte	08h	
Sub-function	2 bytes	0000h	
Data (N word)	2 bytes	N word * 2	Byte order: MSB, LSB
CRC	2 bytes		

Response frame (incorrect action)

Description	Length	Value	Note
Physical Address	1 byte	1 to F7 (1 to 247)	Possible exception: 01h: illegal function 02h: illegal data address
Function code	1 byte	88h	
Exception code	1 byte	01h, 02h, 03h, 04h	

CRC	2 bytes		03h: illegal data value 04h: slave device failure
-----	---------	--	--

1.2.6 Function 14h with sub-function 06h (Reading of record file)

This function code is used to perform a record file read. All the Request Data Lengths are provided in terms of number of bytes and all Record Lengths are provided in terms of registers.

A file is set of records. Each file contains 10000 records, addressed from 0 to 9999.

The function can read multiple groups of references. The groups can be separated (non-contiguous), but the references within each group must be sequential. Each group is defined in a separate 'sub-request' field that contains 7 bytes:

The reference type: 1 byte (must be specified as 6);

The file number: 2 bytes;

The starting record number within the file: 2 bytes;

The length of the record to be read: 2 bytes.

The quantity of registers to be read, combined with all the other fields in the expected response, must not exceed the allowable length of the MODBUS PDU: 253 bytes.

The normal response is a series of 'sub-responses', one for each 'sub-request'. The byte count field is the total combined count of bytes in all 'sub-responses'. In addition, each 'sub-response' contains a field that shows its own byte count.

Request frame

Description	Length	Value	Note
Physical Address	1 byte	1 to F7 (1 to 247)	
Function code	1 byte	14h	
Byte count	1 byte	07h to F5h bytes	
1°Sub-function code	1 byte	06h	
1°Sub-function file number	2 bytes	0h to FFFFh	Byte order: MSB, LSB
1°Sub-function record number	2 bytes	0h to 270Fh	Byte order: MSB, LSB
1°Sub-function number of word (N)	2 bytes	N	Byte order: MSB, LSB
2°Sub-function code	1 byte	06h	
2°Sub-function file number	2 bytes	0h to FFFFh	Byte order: MSB, LSB
2°Sub-function record number	2 bytes	0h to 270Fh	Byte order: MSB, LSB
2°Sub-function number of word (N1)	2 bytes	N1	Byte order: MSB, LSB
....			
CRC	2 bytes		

Response frame (correct action)

Description	Length	Value	Note
Physical Address	1 byte	1 to F7 (1 to 247)	
Function code	1 byte	14h	
Resp. Data length	1 byte	0x07 to 0xF5	
1°Sub-func. response data length	1 byte	07h to 0F5h	
1°Sub-function code	1 byte	06h	
1°Sub-func. Data (N word)	2 bytes	N word * 2	Byte order: MSB, LSB
2°Sub-func. response data length	1 byte	07h to 0F5h	
2°Sub-function code	1 byte	06h	
2°Sub-func. Data (N1 word)	2 bytes	N1 word * 2	Byte order: MSB, LSB
....			
CRC	2 bytes		

Response frame (incorrect action)

Description	Length	Value	Note
Physical Address	1 byte	1 to F7 (1 to 247)	Possible exception : 01h: illegal function 02h: illegal data address 03h: illegal data value 04h: slave device failure
Function code	1 byte	88h	
Exception code	1 byte	01h, 02h, 03h, 04h	
CRC	2 bytes		

1.2.7 Function 42h (Read special registers)

This function code is used to read the contents of a contiguous block of holding registers (word). The request frame specifies the starting register address and the number of registers to be read. It is possible to read maximum 125 register (word) with a single request.

The register data in the response message are packed as two bytes per register (word), with the binary contents right justified within each byte. For each register, the first byte contains the high order bits (MSB) and the second contains the low order bits (LSB).

Request frame

Description	Length	Value	Note
Physical Address	1 byte	1 to F7 (1 to 247)	
Function code	1 byte	42h	
Starting Address	2 bytes	0000h to FFFFh	Byte order: MSB, LSB
Quantity of Registers (N word)	2 bytes	1 to 7Dh (1 to 125)	Byte order: MSB, LSB
CRC	2 bytes		

Response frame (correct action)

Description	Length	Value	Note
Physical Address	1 byte	1 to F7 (1 to 247)	
Function code	1 byte	42h	
Byte count	1 byte	N word * 2	
Register value	N*2 bytes		Byte order: MSB, LSB
CRC	2 bytes		

Response frame (incorrect action)

Description	Length	Value	Note
Physical Address	1 byte	1 to F7 (1 to 247)	Possible exception: 01h: illegal function 02h: illegal data address 03h: illegal data value 04h: slave device failure
Function code	1 byte	83h	
Exception code	1 byte	01h, 02h, 03h, 04h	
CRC	2 bytes		

1.2.8 Broadcast mode

In broadcast mode the master can send a request (command) to the all slaves. No response is returned to broadcast requests sent by the master. It is possible to send the broadcast message only with the function code 06h and 10h and using the address 00h.

1.3 Application notes

1.3.1 General consideration

1. To avoid errors due to the signal reflections or line coupling, it is necessary to terminate the input of the last instrument on the network, and also the reception of the Host. The termination on both the instrument and the host is necessary even in case of point-to-point connection, within short distances.
2. The GND connection is optional if a shielded cable is used.
3. For connections longer than 1000 m, a line amplifier is necessary.
4. If an instrument does not answer within the "max answering time", it is necessary to repeat the query. If the instrument does not answer after 2 or 3 consecutive queries, it must be considered as not connected, faulty or with wrong address. The same consideration is valid in case of CRC errors or incomplete frames.

1.3.2 MODBUS timing

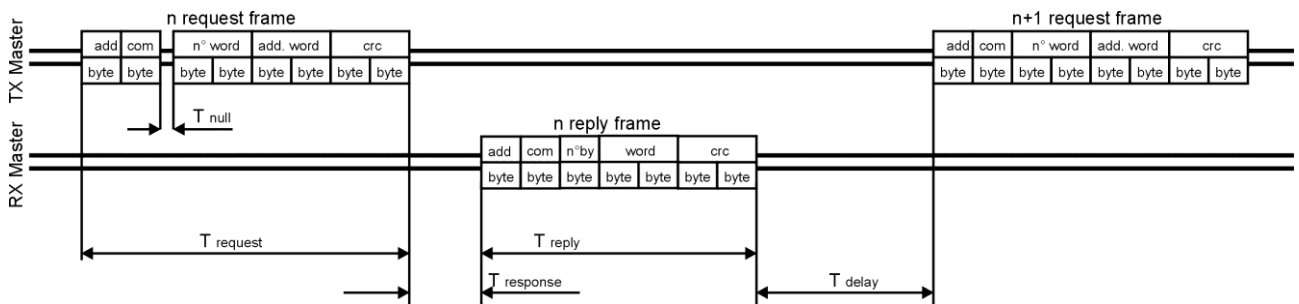

Fig. 1 : 4-wire timing diagram

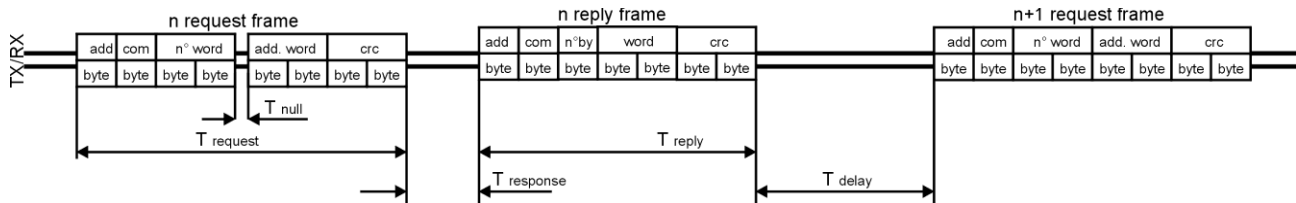

Fig. 2 : 2-wire timing diagram

Timing characteristics of reading function:	msec
T response: Max answering time	1000 ms
T response: Typical answering time @9600 bps	23 ms
T response: Typical answering time @115200 bps	<4 ms
T delay: Minimum time for a new query	9600 baud-rate: 3,5 char 19200 baud-rate: 3,5 char 38400 baud-rate: 1,75 ms 115200 baud-rate: 1,75 ms
T null: Max interruption time on the request frame	9600 baud-rate: 2,5 char 19200 baud-rate: 2,5 char 38400 baud-rate: 1,75 ms 115200 baud-rate: 1,75 ms

Where: n char = $n \cdot 10 / \text{baud rate}$

2 TABLES

2.1 Data format representation in Carlo Gavazzi instruments

The variables are represented by integers or floating numbers, with 2's complement notation in case of "signed" format, using the following:

Format	IEC data type	Description	Bits	Range
INT16	INT	Integer	16	-32768 .. 32767
UINT16	UINT	Unsigned integer	16	0 .. 65535
INT32	DINT	Double integer	32	$-2^{31} .. 2^{31}$
UINT32	UDINT	Unsigned double int	32	$0 .. 2^{32}-1$
UINT64	ULINT	Unsigned long integer	64	$0 .. 2^{64}-1$
IEEE754 SP		Single-precision floating-point	32	$-(1+[1-2^{-23}]) \times 2^{127} .. 2^{128}$

The IEEE754 representation of a 32-bit floating-point number as an integer is defined as follows:

32-bit floating-point

Bits		
31	30 ... 23	22 ... 0
Sign	Exponent	Mantissa

$$(-1)^{sign} * 2^{(Exponent-127)} * 1. Mantissa$$

The byte order in the MODBUS (and ANSI) frame is:

- 1st byte = Bits 15 ... 8 of the 32-bit floating-point number in standard IEEE-754
- 2nd byte = Bits 7 ... 0 of the 32-bit floating-point number in standard IEEE-754
- 3rd byte = Bits 31 ... 24 of the 32-bit floating-point number in standard IEEE-754
- 4th byte = Bits 23 ... 16 of the 32-bit floating-point number in standard IEEE-754

The integers are represented in UINT16 (16 bit) or UINT64 (64 bit) format without sign (the byte order inside the single word is MSB->LSB while the word order is LSW->MSW).

2.1.1 Geometric representation

According to the signs of the power factor, the active power P and the reactive power Q, it is possible to obtain a geometric representation of the power vector, as indicated in the drawing below, according to EN 62053:

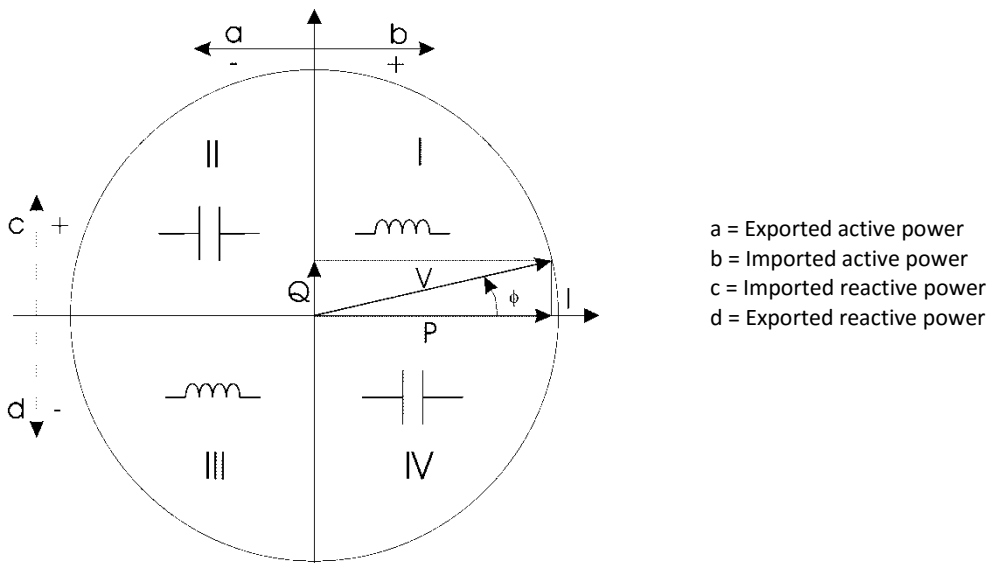

Fig. 3 : Geometric Representation

2.1.2 Maximum and minimum electrical values

The max and min electric values for each variable are indicated in the following table:

AV4: 400/690VLL AC, 1(2)A

VLN : 160 V to 480VLN

VLL : 277 V to 830VLL

AV5: 400/690VLL AC, 5(6)A

VLN : 160 V to 480VLN

VLL : 277 V to 830VLL

AV6: 100/208VLL AC, 5(6)A

VLN : 40 V to 144VLN

VLL : 70 V to 250VLL

AV7: 100/208VLL AC, 1(2)A

VLN : 40 V to 144VLN

VLL : 70 V to 250VLL

2.2 Firmware version

MODBUS: read only mode (with functions code 03 and 04)

Table 2.2-1

Modicom address	Physical address	Length (words)	VARIABLE ENG. UNIT	Data Format	Notes	Firmware compatibility
300001	0000h	1	Base firmware version	UINT 16	MSB: ASCII code for model (A = AV5, B = AV6, C = AV4, D = AV7) LSB: numeric number for revision	X0
300001	0000h	1	Base firmware version	UINT 16	MSB: ASCII code for model (A = AV5, B = AV6, C = AV4, D = AV7) LSB: numeric number for revision	Y0
300001	0000h	1	Base firmware version	UINT 16	MSB: ASCII code for model (A = AV5, B = AV6, C = AV4, D = AV7) LSB: numeric number for revision	Z0
300002	0001h	1	Communication module firmware version (only in case MCETH or MCBACIP or M C BAC MS or MC EI modules)	UINT 16	MSB: ASCII code for model LSB: numeric number for revision	X0, Y0, Z0
300003	0002h	1	Analogue output module firmware version (position 1 - only in case MOA2 or MOV2 modules)	UINT 16	MSB: ASCII code for model (A= MOA2, B= MOV2) LSB: numeric number for revision	X0, Y0
300004	0003h	1	Advanced six channel digital inputs + four channel outputs module firmware version (only in case MFI6R4 or MFI6O6)	UINT 16	MSB: ASCII code for model (A= MFI6R4, B= MFI6O6) LSB: numeric number for revision	Y0
300005	0004h	1	Process module (only in case MATP or MATPN)	UINT 16	MSB: ASCII code for model (A= MATP, B= MATPN) LSB: numeric number for revision	Y0
300006	0005h	1	Analogue output module firmware version (position 2 - only in case MOA2 or MOV2 modules)	UINT 16	MSB: ASCII code for model (A= MOA2, B= MOV2) LSB: numeric number for Revision	Y0
300007	0006h	1	Communication module firmware version (only in case MCPB and MCPBM)	UINT 16	MSB: ASCII code for model LSB: numeric number for revision	X21, Y17, Z0

NOTE 1. In the following document the firmware letter "X" indicates all versions: "A", "B", "C", e "D" only for WM30. The number indicates the firmware revision.

NOTE 2. In the following document the firmware letter "Y" indicates all versions: "A", "B", "C", e "D" only for WM40. The number indicates the firmware revision.

NOTE 3. In the following document the firmware letter "Z" indicates all versions: "A", "B", "C", e "D" only for WM20. The number indicates the firmware revision.

2.3 Carlo Gavazzi Controls identification code

MODBUS: read only mode (with functions code 03 and 04)

Table 2.3-1

Modicom address	Physical address	Length (words)	VARIABLE ENG. UNIT	Data Format	Notes	Firmware compatibility
300012	000Bh	1	Carlo Gavazzi Controls identification code	UINT 16	Value = 0x0041 (65d)	X0
300012	000Bh	1	Carlo Gavazzi Controls identification code	UINT 16	Value = 0x0042 (66d)	Y0
300012	000Bh	1	Carlo Gavazzi Controls identification code	UINT 16	Value = 0x0062 (98d)	Z0

2.4 Serial number

MODBUS: read only mode (with functions code 03 and 04)

Table 2.4-1

Modicom address	Physical address	Length (words)	VARIABLE ENG. UNIT	Data Format	Notes	Firmware compatibility
300033	0020h	1	Letter 1 (from SX) Letter 2 (from SX)	UINT 16	MSB: ASCII code LSB: ASCII code	X2, Y0, Z0
300034	0021h	1	Letter 3 (from SX) Letter 4 (from SX)	UINT 16	MSB: ASCII code LSB: ASCII code	X2, Y0, Z0
300035	0022h	1	Letter 5 (from SX) Letter 6 (from SX)	UINT 16	MSB: ASCII code LSB: ASCII code	X2, Y0, Z0
300036	0023h	1	Letter 7 (from SX) Letter 8 (from SX)	UINT 16	MSB: ASCII code LSB: ASCII code	X2, Y0, Z0
300037	0024h	1	Letter 9 (from SX) Letter 10 (from SX)	UINT 16	MSB: ASCII code LSB: ASCII code	X2, Y0, Z0
300038	0025h	1	Letter 11 (from SX) Letter 12 (from SX)	UINT 16	MSB: ASCII code LSB: ASCII code	X2, Y0, Z0
300039	0026h	1	Letter 13 (from SX)	UINT 16	MSB: ASCII code	X2, Y0, Z0

Note : in WM20 all the letters that make up serial number are upper case even if display shows lower case

2.5 Instantaneous variables

MODBUS: read only mode (with functions code 03 and 04)

Table 2.5-1

Modicom address	Physical address	Length (words)	VARIABLE ENG. UNIT	Data Format	Notes	Firmware compatibility
300081	0050h	2	V L1-N	32 bit IEEE 754		X0, Y0, Z0
300083	0052h	2	V L2-N	32 bit IEEE 754		X0, Y0, Z0
300085	0054h	2	V L3-N	32 bit IEEE 754		X0, Y0, Z0
300087	0056h	2	V L-N Σ	32 bit IEEE 754		X0, Y0, Z0
300089	0058h	2	V L1-L2	32 bit IEEE 754		X0, Y0, Z0
300091	005Ah	2	V L2-L3	32 bit IEEE 754		X0, Y0, Z0
300093	005Ch	2	V L3-L1	32 bit IEEE 754		X0, Y0, Z0
300095	005Eh	2	V L-L Σ	32 bit IEEE 754		X0, Y0, Z0
300097	0060h	2	A L1	32 bit IEEE 754		X0, Y0, Z0
300099	0062h	2	A L2	32 bit IEEE 754		X0, Y0, Z0
300101	0064h	2	A L3	32 bit IEEE 754		X0, Y0, Z0
300103	0066h	2	A N	32 bit IEEE 754	Calculated by instrument base	X0, Y0, Z0
					Measured by optional module	Y0
300105	0068h	2	W L1	32 bit IEEE 754		X0, Y0, Z0
300107	006Ah	2	W L2	32 bit IEEE 754		X0, Y0, Z0
300109	006Ch	2	W L3	32 bit IEEE 754		X0, Y0, Z0
300111	006Eh	2	W Σ	32 bit IEEE 754		X0, Y0, Z0
300113	0070h	2	VA L1	32 bit IEEE 754		X0, Y0, Z0
300115	0072h	2	VA L2	32 bit IEEE 754		X0, Y0, Z0
300117	0074h	2	VA L3	32 bit IEEE 754		X0, Y0, Z0
300119	0076h	2	VA Σ	32 bit IEEE 754		X0, Y0, Z0
300121	0078h	2	VAR L1	32 bit IEEE 754		X0, Y0, Z0
300123	007Ah	2	VAR L2	32 bit IEEE 754		X0, Y0, Z0
300125	007Ch	2	VAR L3	32 bit IEEE 754		X0, Y0, Z0
300127	007Eh	2	VAR Σ	32 bit IEEE 754		X0, Y0, Z0
300129	0080h	2	PF L1	32 bit IEEE 754	Negative values correspond to lead(C), positive values correspond to lag(L)	X0, Y0, Z0
300131	0082h	2	PF L2	32 bit IEEE 754		
300133	0084h	2	PF L3	32 bit IEEE 754		
300135	0086h	2	PF Σ	32 bit IEEE 754		
300137	0088h	2	Hz	32 bit IEEE 754		X0, Y0, Z0
300139	008Ah	2	Asymmetry L-N %	32 bit IEEE 754		X0, Y0, Z0
300141	008Ch	2	Asymmetry L-L %	32 bit IEEE 754		X0, Y0, Z0
300143	008Eh	2	Phase sequence	32 bit IEEE 754	Value +1 corresponds to the L1-L2-L3 sequence, value -1 corresponds to wrong sequence	X0, Y0, Z0
300145	0090h	2	A Σ	32 bit IEEE 754		X16, Z0
300145	0090h	2	K-Factor L1	32 bit IEEE 754		Y0
300147	0092h	2	K-Factor L2	32 bit IEEE 754		Y0
300149	0094h	2	K-Factor L3	32 bit IEEE 754		Y0
300151	0096h	2	Temperature	32 bit IEEE 754	Only by optional module	Y0
300153	0098h	2	Analogue Input	32 bit IEEE 754	Only by optional module	Y0
300155	009Ah	2	A Σ	32 bit IEEE 754		Y13
300161	00A0h	2	THD tot VL1-N	32 bit IEEE 754		X0, Y0, Z0
300163	00A2h	2	THD tot VL2-N	32 bit IEEE 754		X0, Y0, Z0
300165	00A4h	2	THD tot VL3-N	32 bit IEEE 754		X0, Y0, Z0
300167	00A6h	2	THD tot VL12	32 bit IEEE 754		X0, Y0, Z0
300169	00A8h	2	THD tot VL23	32 bit IEEE 754		X0, Y0, Z0
300171	00AAh	2	THD tot VL31	32 bit IEEE 754		X0, Y0, Z0
300173	00ACh	2	THD tot AL1	32 bit IEEE 754		X0, Y0, Z0
300175	00AEh	2	THD tot AL2	32 bit IEEE 754		X0, Y0, Z0
300177	00B0h	2	THD tot AL3	32 bit IEEE 754		X0, Y0, Z0
300179	00B2h	2	THD odd VL1-N	32 bit IEEE 754		Y0
300181	00B4h	2	THD odd VL2-N	32 bit IEEE 754		Y0
300183	00B6h	2	THD odd VL3-N	32 bit IEEE 754		Y0
300185	00B8h	2	THD odd VL12	32 bit IEEE 754		Y0
300187	00BAh	2	THD odd VL23	32 bit IEEE 754		Y0
300189	00BCh	2	THD odd VL31	32 bit IEEE 754		Y0
300191	00BEh	2	THD odd AL1	32 bit IEEE 754		Y0
300193	00C0h	2	THD odd AL2	32 bit IEEE 754		Y0
300195	00C2h	2	THD odd AL3	32 bit IEEE 754		Y0
300197	00C4h	2	THD even VL1-N	32 bit IEEE 754		Y0
300199	00C6h	2	THD even VL2-N	32 bit IEEE 754		Y0
300201	00C8h	2	THD even VL3-N	32 bit IEEE 754		Y0
300203	00CAh	2	THD even VL12	32 bit IEEE 754		Y0
300205	00CCh	2	THD even VL23	32 bit IEEE 754		Y0

300207	00CEh	2	THD even VL31	32 bit IEEE 754	Y0
300209	00D0h	2	THD even AL1	32 bit IEEE 754	Y0
300211	00D2h	2	THD even AL2	32 bit IEEE 754	Y0
300213	00D4h	2	THD even AL3	32 bit IEEE 754	Y0
300215	00D6h	2	TDD tot AL1	32 bit IEEE 754	Y0
300217	00D8h	2	TDD tot AL2	32 bit IEEE 754	Y0
300219	00DAh	2	TDD tot AL3	32 bit IEEE 754	Y0

2.6 Maximum variables

MODBUS: read only mode (with functions code 03 and 04)

Table 2.6-1

Modicom address	Physical address	Length (words)	VARIABLE ENG. UNIT	Data Format	Notes	Firmware compatibility
300337	0150h	2	Max V L1-N	32 bit IEEE 754		X0, Y0
300339	0152h	2	Max V L2-N	32 bit IEEE 754		X0, Y0
300341	0154h	2	Max V L3-N	32 bit IEEE 754		X0, Y0
300343	0156h	2	Max V L-N Σ	32 bit IEEE 754		X0, Y0
300345	0158h	2	Max V L1-L2	32 bit IEEE 754		X0, Y0
300347	015Ah	2	Max V L2-L3	32 bit IEEE 754		X0, Y0
300349	015Ch	2	Max V L3-L1	32 bit IEEE 754		X0, Y0
300351	015Eh	2	Max V L-L Σ	32 bit IEEE 754		X0, Y0
300353	0160h	2	Max A L1	32 bit IEEE 754		X0, Y0
300355	0162h	2	Max A L2	32 bit IEEE 754		X0, Y0
300357	0164h	2	Max A L3	32 bit IEEE 754		X0, Y0
300359	0166h	2	Max A N	32 bit IEEE 754		X0, Y0
300361	0168h	2	Max W L1	32 bit IEEE 754		X0, Y0, Z0
300363	016Ah	2	Max W L2	32 bit IEEE 754		X0, Y0, Z0
300365	016Ch	2	Max W L3	32 bit IEEE 754		X0, Y0, Z0
300367	016Eh	2	Max W Σ	32 bit IEEE 754		X0, Y0, Z0
300369	0170h	2	Max VA L1	32 bit IEEE 754		X0, Y0, Z0
300371	0172h	2	Max VA L2	32 bit IEEE 754		X0, Y0, Z0
300373	0174h	2	Max VA L3	32 bit IEEE 754		X0, Y0, Z0
300375	0176h	2	Max VA Σ	32 bit IEEE 754		X0, Y0, Z0
300377	0178h	2	Max VAR L1	32 bit IEEE 754		X0, Y0, Z0
300379	017Ah	2	Max VAR L2	32 bit IEEE 754		X0, Y0, Z0
300381	017Ch	2	Max VAR L3	32 bit IEEE 754		X0, Y0, Z0
300383	017Eh	2	Max VAR Σ	32 bit IEEE 754		X0, Y0, Z0
300385	0180h	2	Max PF L1	32 bit IEEE 754	Negative values correspond to lead(C), positive values correspond to lag(L)	X0, Y0
300387	0182h	2	Max PF L2	32 bit IEEE 754		
300389	0184h	2	Max PF L3	32 bit IEEE 754		
300391	0186h	2	Max PF Σ	32 bit IEEE 754		
300393	0188h	2	Max Hz	32 bit IEEE 754		X0, Y0
300395	018Ah	2	Max Asymmetry L-N %	32 bit IEEE 754		X0, Y0
300397	018Ch	2	Max Asymmetry L-L %	32 bit IEEE 754		X0, Y0
300399	018Eh	2	RESERVED			
300401	0190h	2	Max A Σ	32 bit IEEE 754		X16
300401	0190h	2	Max K-Factor L1	32 bit IEEE 754		Y0
300403	0192h	2	Max K-Factor L2	32 bit IEEE 754		Y0
300405	0194h	2	Max K-Factor L3	32 bit IEEE 754		Y0
300407	0196h	2	Max Temperature	32 bit IEEE 754	Only by optional module	Y0
300409	0198h	2	Max Analogue Input	32 bit IEEE 754	Only by optional module	Y0
300411	019Ah	2	Max A Σ	32 bit IEEE 754		Y13
300417	01A0h	2	Max THD tot VL1-N	32 bit IEEE 754		X0, Y0
300419	01A2h	2	Max THD tot VL2-N	32 bit IEEE 754		X0, Y0
300421	01A4h	2	Max THD tot VL3-N	32 bit IEEE 754		X0, Y0
300423	01A6h	2	Max THD tot VL12	32 bit IEEE 754		X0, Y0
300425	01A8h	2	Max THD tot VL23	32 bit IEEE 754		X0, Y0
300427	01AAh	2	Max THD tot VL31	32 bit IEEE 754		X0, Y0
300429	01ACh	2	Max THD tot AL1	32 bit IEEE 754		X0, Y0
300431	01AEh	2	Max THD tot AL2	32 bit IEEE 754		X0, Y0
300433	01B0h	2	Max THD tot AL3	32 bit IEEE 754		X0, Y0
300435	01B2h	2	Max THD odd VL1-N	32 bit IEEE 754		Y0
300437	01B4h	2	Max THD odd VL2-N	32 bit IEEE 754		Y0
300439	01B6h	2	Max THD odd VL3-N	32 bit IEEE 754		Y0
300441	01B8h	2	Max THD odd VL12	32 bit IEEE 754		Y0
300443	01BAh	2	Max THD odd VL23	32 bit IEEE 754		Y0
300445	01BCh	2	Max THD odd VL31	32 bit IEEE 754		Y0
300447	01BEh	2	Max THD odd AL1	32 bit IEEE 754		Y0
300449	01C0h	2	Max THD odd AL2	32 bit IEEE 754		Y0
300451	01C2h	2	Max THD odd AL3	32 bit IEEE 754		Y0
300453	01C4h	2	Max THD even VL1-N	32 bit IEEE 754		Y0
300455	01C6h	2	Max THD even VL2-N	32 bit IEEE 754		Y0
300457	01C8h	2	Max THD even VL3-N	32 bit IEEE 754		Y0

300459	01CAh	2	Max THD even VL12	32 bit IEEE 754	YO
300461	01CCh	2	Max THD even VL23	32 bit IEEE 754	YO
300463	01CEh	2	Max THD even VL31	32 bit IEEE 754	YO
300465	01D0h	2	Max THD even AL1	32 bit IEEE 754	YO
300467	01D2h	2	Max THD even AL2	32 bit IEEE 754	YO
300469	01D4h	2	Max THD even AL3	32 bit IEEE 754	YO
300471	01D6h	2	Max TDD tot AL1	32 bit IEEE 754	YO
300473	01D8h	2	Max TDD tot AL2	32 bit IEEE 754	YO
300475	01DAh	2	Max TDD tot AL3	32 bit IEEE 754	YO

2.7 Minimum variables

MODBUS: read only mode (with functions code 03 and 04)

Table 2.7-1

Modicom address	Physical address	Length (words)	VARIABLE ENG. UNIT	Data Format	Notes	Firmware compatibility
300593	0250h	2	Min V L1-N	32 bit IEEE 754		YO
300595	0252h	2	Min V L2-N	32 bit IEEE 754		YO
300597	0254h	2	Min V L3-N	32 bit IEEE 754		YO
300599	0256h	2	Min V L-N Σ	32 bit IEEE 754		YO
300601	0258h	2	Min V L1-L2	32 bit IEEE 754		YO
300603	025Ah	2	Min V L2-L3	32 bit IEEE 754		YO
300605	025Ch	2	Min V L3-L1	32 bit IEEE 754		YO
300607	025Eh	2	Min V L-L Σ	32 bit IEEE 754		YO
300609	0260h	2	Min A L1	32 bit IEEE 754		YO
300611	0262h	2	Min A L2	32 bit IEEE 754		YO
300613	0264h	2	Min A L3	32 bit IEEE 754		YO
300615	0266h	2	Min A N	32 bit IEEE 754		YO
300617	0268h	2	Min W L1	32 bit IEEE 754		YO
300619	026Ah	2	Min W L2	32 bit IEEE 754		YO
300621	026Ch	2	Min W L3	32 bit IEEE 754		YO
300623	026Eh	2	Min W Σ	32 bit IEEE 754		YO
300625	0270h	2	Min VA L1	32 bit IEEE 754		YO
300627	0272h	2	Min VA L2	32 bit IEEE 754		YO
300629	0274h	2	Min VA L3	32 bit IEEE 754		YO
300631	0276h	2	Min VA Σ	32 bit IEEE 754		YO
300633	0278h	2	Min VAR L1	32 bit IEEE 754		YO
300635	027Ah	2	Min VAR L2	32 bit IEEE 754		YO
300637	027Ch	2	Min VAR L3	32 bit IEEE 754		YO
300639	027Eh	2	Min VAR Σ	32 bit IEEE 754		YO
300641	0280h	2	Min PF L1	32 bit IEEE 754	Negative values correspond to lead(C), positive values correspond to lag(L)	YO
300643	0282h	2	Min PF L2	32 bit IEEE 754		
300645	0284h	2	Min PF L3	32 bit IEEE 754		
300647	0286h	2	Min PF Σ	32 bit IEEE 754		
300649	0288h	2	Min Hz	32 bit IEEE 754		YO
300651	028Ah	2	Min Asymmetry L-N %	32 bit IEEE 754		YO
300653	028Ch	2	Min Asymmetry L-L %	32 bit IEEE 754		YO
300655	028Eh	2	RESERVED			YO
300657	0290h	2	Min K-Factor L1	32 bit IEEE 754		YO
300659	0292h	2	Min K-Factor L2	32 bit IEEE 754		YO
300661	0294h	2	Min K-Factor L3	32 bit IEEE 754		YO
300663	0296h	2	Min Temperature	32 bit IEEE 754	Only by optional module	YO
300665	0298h	2	Min Analogue Input	32 bit IEEE 754	Only by optional module	YO
300667	029Ah	2	Min A Σ	32 bit IEEE 754		Y13
300673	02A0h	2	Min THD tot VL1-N	32 bit IEEE 754		YO
300675	02A2h	2	Min THD tot VL2-N	32 bit IEEE 754		YO
300677	02A4h	2	Min THD tot VL3-N	32 bit IEEE 754		YO
300679	02A6h	2	Min THD tot VL12	32 bit IEEE 754		YO
300681	02A8h	2	Min THD tot VL23	32 bit IEEE 754		YO
300683	02AAh	2	Min THD tot VL31	32 bit IEEE 754		YO
300685	02ACh	2	Min THD tot AL1	32 bit IEEE 754		YO
300687	02AEh	2	Min THD tot AL2	32 bit IEEE 754		YO
300689	02B0h	2	Min THD tot AL3	32 bit IEEE 754		YO
300691	02B2h	2	Min THD odd VL1-N	32 bit IEEE 754		YO
300693	02B4h	2	Min THD odd VL2-N	32 bit IEEE 754		YO
300695	02B6h	2	Min THD odd VL3-N	32 bit IEEE 754		YO
300697	02B8h	2	Min THD odd VL12	32 bit IEEE 754		YO
300699	02BAh	2	Min THD odd VL23	32 bit IEEE 754		YO
300701	02BCh	2	Min THD odd VL31	32 bit IEEE 754		YO
300703	02BEh	2	Min THD odd AL1	32 bit IEEE 754		YO
300705	02C0h	2	Min THD odd AL2	32 bit IEEE 754		YO
300707	02C2h	2	Min THD odd AL3	32 bit IEEE 754		YO
300709	02C4h	2	Min THD even VL1-N	32 bit IEEE 754		YO
300711	02C6h	2	Min THD even VL2-N	32 bit IEEE 754		YO

300713	02C8h	2	Min THD even VL3-N	32 bit IEEE 754	YO
300715	02CAh	2	Min THD even VL12	32 bit IEEE 754	YO
300717	02CCh	2	Min THD even VL23	32 bit IEEE 754	YO
300719	02CEh	2	Min THD even VL31	32 bit IEEE 754	YO
300721	02D0h	2	Min THD even AL1	32 bit IEEE 754	YO
300723	02D2h	2	Min THD even AL2	32 bit IEEE 754	YO
300725	02D4h	2	Min THD even AL3	32 bit IEEE 754	YO
300727	02D6h	2	Min TDD tot AL1	32 bit IEEE 754	YO
300729	02D8h	2	Min TDD tot AL2	32 bit IEEE 754	YO
300731	02DAh	2	Min TDD tot AL3	32 bit IEEE 754	YO

2.8 DMD variables

MODBUS: read only mode (with functions code 03 and 04)

Table 2.8-1

Modicom address	Physical address	Length (words)	VARIABLE ENG. UNIT	Data Format	Notes	Firmware compatibility
300849	0350h	2	DMD V L1-N	32 bit IEEE 754		X0, Y0
300851	0352h	2	DMD V L2-N	32 bit IEEE 754		X0, Y0
300853	0354h	2	DMD V L3-N	32 bit IEEE 754		X0, Y0
300855	0356h	2	DMD V L-N Σ	32 bit IEEE 754		X0, Y0
300857	0358h	2	DMD V L1-L2	32 bit IEEE 754		X0, Y0
300859	035Ah	2	DMD V L2-L3	32 bit IEEE 754		X0, Y0
300861	035Ch	2	DMD V L3-L1	32 bit IEEE 754		X0, Y0
300863	035Eh	2	DMD V L-L Σ	32 bit IEEE 754		X0, Y0
300865	0360h	2	DMD A L1	32 bit IEEE 754		X0, Y0
300867	0362h	2	DMD A L2	32 bit IEEE 754		X0, Y0
300869	0364h	2	DMD A L3	32 bit IEEE 754		X0, Y0
300871	0366h	2	DMD A N	32 bit IEEE 754		X0, Y0
300873	0368h	2	DMD W L1	32 bit IEEE 754		X0, Y0, Z0
300875	036Ah	2	DMD W L2	32 bit IEEE 754		X0, Y0, Z0
300877	036Ch	2	DMD W L3	32 bit IEEE 754		X0, Y0, Z0
300879	036Eh	2	DMD W Σ	32 bit IEEE 754		X0, Y0, Z0
300881	0370h	2	DMD VA L1	32 bit IEEE 754		X0, Y0, Z0
300883	0372h	2	DMD VA L2	32 bit IEEE 754		X0, Y0, Z0
300885	0374h	2	DMD VA L3	32 bit IEEE 754		X0, Y0, Z0
300887	0376h	2	DMD VA Σ	32 bit IEEE 754		X0, Y0, Z0
300889	0378h	2	DMD VAR L1	32 bit IEEE 754		X0, Y0, Z0
300891	037Ah	2	DMD VAR L2	32 bit IEEE 754		X0, Y0, Z0
300893	037Ch	2	DMD VAR L3	32 bit IEEE 754		X0, Y0, Z0
300895	037Eh	2	DMD VAR Σ	32 bit IEEE 754		X0, Y0, Z0
300897	0380h	2	DMD PF L1	32 bit IEEE 754	Negative values correspond to lead(C), positive values correspond to lag(L)	X0, Y0
300899	0382h	2	DMD PF L2	32 bit IEEE 754		
300901	0384h	2	DMD PF L3	32 bit IEEE 754		
300903	0386h	2	DMD PF Σ	32 bit IEEE 754		
300905	0388h	2	DMD Hz	32 bit IEEE 754		X0, Y0
300907	038Ah	2	DMD Asymmetry L-N %	32 bit IEEE 754		X0, Y0
300909	038Ch	2	DMD Asymmetry L-L %	32 bit IEEE 754		X0, Y0
300911	038Eh	2	RESERVED			
300913	0390h	2	DMD A Σ	32 bit IEEE 754		X16
300913	0390h	2	DMD K-Factor L1	32 bit IEEE 754		Y0
300915	0392h	2	DMD K-Factor L2	32 bit IEEE 754		Y0
300917	0394h	2	DMD K-Factor L3	32 bit IEEE 754		Y0
300919	0396h	2	DMD Temperature	32 bit IEEE 754	Only by optional module	Y0
300921	0398h	2	DMD Analogue Input	32 bit IEEE 754	Only by optional module	Y0
300923	039Ah	2	DMD A Σ	32 bit IEEE 754		Y13
300929	03A0h	2	DMD THD tot VL1-N	32 bit IEEE 754		X21,Y0
300931	03A2h	2	DMD THD tot VL2-N	32 bit IEEE 754		X21,Y0
300933	03A4h	2	DMD THD tot VL3-N	32 bit IEEE 754		X21,Y0
300935	03A6h	2	DMD THD tot VL12	32 bit IEEE 754		X21,Y0
300937	03A8h	2	DMD THD tot VL23	32 bit IEEE 754		X21,Y0
300939	03AAh	2	DMD THD tot VL31	32 bit IEEE 754		X21,Y0
300941	03ACh	2	DMD THD tot AL1	32 bit IEEE 754		X21,Y0
300943	03AEh	2	DMD THD tot AL2	32 bit IEEE 754		X21,Y0
300945	03B0h	2	DMD THD tot AL3	32 bit IEEE 754		X21,Y0
300947	03B2h	2	DMD THD odd VL1-N	32 bit IEEE 754		Y0
300949	03B4h	2	DMD THD odd VL2-N	32 bit IEEE 754		Y0
300951	03B6h	2	DMD THD odd VL3-N	32 bit IEEE 754		Y0
300953	03B8h	2	DMD THD odd VL12	32 bit IEEE 754		Y0
300955	03BAh	2	DMD THD odd VL23	32 bit IEEE 754		Y0
300957	03BCh	2	DMD THD odd VL31	32 bit IEEE 754		Y0
300959	03BEh	2	DMD THD odd AL1	32 bit IEEE 754		Y0
300961	03C0h	2	DMD THD odd AL2	32 bit IEEE 754		Y0
300963	03C2h	2	DMD THD odd AL3	32 bit IEEE 754		Y0

300965	03C4h	2	DMD THD even VL1-N	32 bit IEEE 754	YO
300967	03C6h	2	DMD THD even VL2-N	32 bit IEEE 754	YO
300969	03C8h	2	DMD THD even VL3-N	32 bit IEEE 754	YO
300971	03CAh	2	DMD THD even VL12	32 bit IEEE 754	YO
300973	03CCh	2	DMD THD even VL23	32 bit IEEE 754	YO
300975	03CEh	2	DMD THD even VL31	32 bit IEEE 754	YO
300977	03D0h	2	DMD THD even AL1	32 bit IEEE 754	YO
300979	03D2h	2	DMD THD even AL2	32 bit IEEE 754	YO
300981	03D4h	2	DMD THD even AL3	32 bit IEEE 754	YO
300983	03D6h	2	DMD TDD tot AL1	32 bit IEEE 754	YO
300985	03D8h	2	DMD TDD tot AL2	32 bit IEEE 754	YO
300987	03DAh	2	DMD TDD tot AL3	32 bit IEEE 754	YO

2.9 Maximum DMD variables

MODBUS: read only mode (with functions code 03 and 04)

Table 2.9-1

Modicom address	Physical address	Length (words)	VARIABLE ENG. UNIT	Data Format	Notes	Firmware compatibility
301105	0450h	2	DMD Max V L1-N	32 bit IEEE 754		YO
301107	0452h	2	DMD Max V L2-N	32 bit IEEE 754		YO
301109	0454h	2	DMD Max V L3-N	32 bit IEEE 754		YO
301111	0456h	2	DMD Max V L-N Σ	32 bit IEEE 754		YO
301113	0458h	2	DMD Max V L1-L2	32 bit IEEE 754		YO
301115	045Ah	2	DMD Max V L2-L3	32 bit IEEE 754		YO
301117	045Ch	2	DMD Max V L3-L1	32 bit IEEE 754		YO
301119	045Eh	2	DMD Max V L-L Σ	32 bit IEEE 754		YO
301121	0460h	2	DMD Max A L1	32 bit IEEE 754		YO
301123	0462h	2	DMD Max A L2	32 bit IEEE 754		YO
301125	0464h	2	DMD Max A L3	32 bit IEEE 754		YO
301127	0466h	2	DMD Max A N	32 bit IEEE 754		YO
301129	0468h	2	DMD Max W L1	32 bit IEEE 754		YO
301131	046Ah	2	DMD Max W L2	32 bit IEEE 754		YO
301133	046Ch	2	DMD Max W L3	32 bit IEEE 754		YO
301135	046Eh	2	DMD Max W Σ	32 bit IEEE 754		YO
301137	0470h	2	DMD Max VA L1	32 bit IEEE 754		YO
301139	0472h	2	DMD Max VA L2	32 bit IEEE 754		YO
301141	0474h	2	DMD Max VA L3	32 bit IEEE 754		YO
301143	0476h	2	DMD Max VA Σ	32 bit IEEE 754		YO
301145	0478h	2	DMD Max VAR L1	32 bit IEEE 754		YO
301147	047Ah	2	DMD Max VAR L2	32 bit IEEE 754		YO
301149	047Ch	2	DMD Max VAR L3	32 bit IEEE 754		YO
301151	047Eh	2	DMD Max VAR Σ	32 bit IEEE 754		YO
301153	0480h	2	DMD Max PF L1	32 bit IEEE 754	Negative values correspond to lead(C), positive values correspond to lag(L)	YO
301155	0482h	2	DMD Max PF L2	32 bit IEEE 754		YO
301157	0484h	2	DMD Max PF L3	32 bit IEEE 754		YO
301159	0486h	2	DMD Max PF Σ	32 bit IEEE 754		YO
301161	0488h	2	DMD Max Hz	32 bit IEEE 754		YO
301163	048Ah	2	DMD Max Asymmetry L-N %	32 bit IEEE 754		YO
301165	048Ch	2	DMD Max Asymmetry L-L %	32 bit IEEE 754		YO
301167	048Eh	2	RESERVED			YO
301169	0490h	2	DMD Max K-Factor L1	32 bit IEEE 754		YO
301171	0492h	2	DMD Max K-Factor L2	32 bit IEEE 754		YO
301173	0494h	2	DMD Max K-Factor L3	32 bit IEEE 754		YO
301175	0496h	2	DMD Max Temperature	32 bit IEEE 754	Only by optional module	YO
301177	0498h	2	DMD Max Analogue Input	32 bit IEEE 754	Only by optional module	YO
301179	049Ah	2	DMD Max A Σ	32 bit IEEE 754		Y13
301185	04A0h	2	DMD MAX THD tot VL1-N	32 bit IEEE 754		YO
301187	04A2h	2	DMD MAX THD tot VL2-N	32 bit IEEE 754		YO
301189	04A4h	2	DMD MAX THD tot VL3-N	32 bit IEEE 754		YO
301191	04A6h	2	DMD MAX THD tot VL12	32 bit IEEE 754		YO
301193	04A8h	2	DMD MAX THD tot VL23	32 bit IEEE 754		YO
301195	04AAh	2	DMD MAX THD tot VL31	32 bit IEEE 754		YO
301197	04ACh	2	DMD MAX THD tot AL1	32 bit IEEE 754		YO
301199	04AEh	2	DMD MAX THD tot AL2	32 bit IEEE 754		YO
301201	04B0h	2	DMD MAX THD tot AL3	32 bit IEEE 754		YO
301203	04B2h	2	DMD MAX THD odd VL1-N	32 bit IEEE 754		YO
301205	04B4h	2	DMD MAX THD odd VL2-N	32 bit IEEE 754		YO
301207	04B6h	2	DMD MAX THD odd VL3-N	32 bit IEEE 754		YO
301209	04B8h	2	DMD MAX THD odd VL12	32 bit IEEE 754		YO
301211	04BAh	2	DMD MAX THD odd VL23	32 bit IEEE 754		YO
301213	04BCh	2	DMD MAX THD odd VL31	32 bit IEEE 754		YO
301215	04BEh	2	DMD MAX THD odd AL1	32 bit IEEE 754		YO
301217	04C0h	2	DMD MAX THD odd AL2	32 bit IEEE 754		YO

301219	04C2h	2	DMD MAX THD odd AL3	32 bit IEEE 754	Y0
301221	04C4h	2	DMD MAX THD even VL1-N	32 bit IEEE 754	Y0
301223	04C6h	2	DMD MAX THD even VL2-N	32 bit IEEE 754	Y0
301225	04C8h	2	DMD MAX THD even VL3-N	32 bit IEEE 754	Y0
301227	04CAh	2	DMD MAX THD even VL12	32 bit IEEE 754	Y0
301229	04CCh	2	DMD MAX THD even VL23	32 bit IEEE 754	Y0
301231	04CEh	2	DMD MAX THD even VL31	32 bit IEEE 754	Y0
301233	04D0h	2	DMD MAX THD even AL1	32 bit IEEE 754	Y0
301235	04D2h	2	DMD MAX THD even AL2	32 bit IEEE 754	Y0
301237	04D4h	2	DMD MAX THD even AL3	32 bit IEEE 754	Y0
301239	04D6h	2	DMD MAX TDD tot AL1	32 bit IEEE 754	Y0
301241	04D8h	2	DMD MAX TDD tot AL2	32 bit IEEE 754	Y0
301243	04DAh	2	DMD MAX TDD tot AL3	32 bit IEEE 754	Y0

2.10 Total and partial (tariff) energy meters

MODBUS: read only mode (with functions code 03 and 04)

Table 2.10-1

Modicom address	Physical address	Length (words)	VARIABLE ENG. UNIT	Data Format	Notes	Firmware compatibility
301281	0500h	4	Total kWh+	UINT 64	Values in Wh or varh	X0, Y0, Z0
301285	0504h	4	Total Kvarh+	UINT 64		
301289	0508h	4	Total kWh-	UINT 64		
301293	050Ch	4	Total Kvarh-	UINT 64		
301297	0510h	4	Partial kWh+	UINT 64		
301301	0514h	4	Partial Kvarh+	UINT 64		
301305	0518h	4	Partial kWh-	UINT 64		
301309	051Ch	4	Partial Kvarh-	UINT 64		
301313	0520h	4	Hours counter	UINT 64	Hours value: integer part got from the division of the counter by 100 Minutes value: rest of the previous computation (decimal part)	X0, Y0, Z0
301317	0524h	4	Tariff 1 kWh+	UINT 64	Values in Wh or varh. Only by optional module.	Y0
301321	0528h	4	Tariff 1 Kvarh+	UINT 64		
301325	052Ch	4	Tariff 1 kWh-	UINT 64		
301329	0530h	4	Tariff 1 Kvarh-	UINT 64		
301333	0534h	4	Tariff 2 kWh+	UINT 64		
301337	0538h	4	Tariff 2 Kvarh+	UINT 64		
301341	053Ch	4	Tariff 2 kWh-	UINT 64		
301345	0540h	4	Tariff 2 Kvarh-	UINT 64		
301349	0544h	4	Tariff 3 kWh+	UINT 64		
301353	0548h	4	Tariff 3 Kvarh+	UINT 64		
301357	054Ch	4	Tariff 3 kWh-	UINT 64		
301361	0550h	4	Tariff 3 Kvarh-	UINT 64		
301365	0554h	4	Tariff 4 kWh+	UINT 64		
301369	0558h	4	Tariff 4 Kvarh+	UINT 64		
301373	055Ch	4	Tariff 4 kWh-	UINT 64		
301377	0560h	4	Tariff 4 Kvarh-	UINT 64		
301381	0564h	4	Tariff 5 kWh+	UINT 64		
301385	0568h	4	Tariff 5 Kvarh+	UINT 64		
301389	056Ch	4	Tariff 5 kWh-	UINT 64		
301393	0570h	4	Tariff 5 Kvarh-	UINT 64		
301397	0574h	4	Tariff 6 kWh+	UINT 64		
301401	0578h	4	Tariff 6 Kvarh+	UINT 64		
301405	057Ch	4	Tariff 6 kWh-	UINT 64		
301409	0580h	4	Tariff 6 Kvarh-	UINT 64		
301413	0584h	4	C-1	UINT 64	Only by optional module.	
301417	0588h	4	C-2	UINT 64		
301421	058Ch	4	C-3	UINT 64		
301521	05F0h	1	Real Time tariff	UINT 16	Tariff1 0 Tariff2 1 Tariff3 2 Tariff4 3 Tariff5 4 Tariff6 5 Tariff_Disable 6	

2.11 Harmonic analysis

MODBUS: read only mode (with functions code 03 and 04)

Table 2.11-1



Modicom address	Physical address	Length (words)	VARIABLE ENG. UNIT	Data Format	Notes	Firmware compatibility
301537	0600h	71	V L1-N	Custom Harmonic data structure	Table 2.11-2	YO
301617	0650h	71	V L2-N	Custom Harmonic data structure		
301697	06A0h	71	V L3-N	Custom Harmonic data structure		
301777	06F0h	71	V L1-L2	Custom Harmonic data structure		
301857	0740h	71	V L2-L3	Custom Harmonic data structure		
301937	0790h	71	V L3-L1	Custom Harmonic data structure		
302017	07E0h	71	A L1	Custom Harmonic data structure		
302097	0830h	71	A L2	Custom Harmonic data structure		
302177	0880h	71	A L3	Custom Harmonic data structure		

Custom Harmonic data structure

Table 2.11-2

Modicom address	Physical address	Length (words)	VARIABLE ENG. UNIT	Data Format	Notes	Firmware compatibility
Block address +0	Block address +0	1	Number of sample	UINT 16		YO
Block address +1	Block address +1	2	Frequency	32 bit IEEE 754		YO
Block address +3	Block address +3	2	RMS value	32 bit IEEE 754		YO
Block address +5	Block address +5	1	Re (FFT(0))	UINT 16		YO
Block address +6	Block address +6	1	Re (FFT(1))	UINT 16		YO
...	YO
Block address +3	Block address +37	1	Re (FFT(32))	INT 16		YO
Block address +38	Block address +38	1	Im (FFT(0))	INT 16		YO
Block address +39	Block address +39	1	Im (FFT(1))	INT 16		YO
...	YO
Block address +71	Block address +71	1	Im (FFT(32))	INT 16		YO

2.11.1 Harmonic phase angles

MODBUS: read only mode with functions code 03 and 04

Table 2.11-3

Modicom address	Physical address	Length (words)	VARIABLE ENG. UNIT	Data Format	Notes	Firmware compatibility
302305	0900h	1	1° harmonic Ph. Angle VL1-N→AL1 [°]	UINT 16		YO
302306	0901h	1	2° harmonic Ph. Angle VL1-N→AL1 [°]	UINT 16		YO
...	YO
302335	091Eh	1	30° harmonic Ph. Angle VL1-N→AL1 [°]	UINT 16		YO
302336	091Fh	1	31° harmonic Ph. Angle VL1-N→AL1 [°]	UINT 16		YO
302337	0920h	1	1° harmonic Ph. Angle VL2-N→AL2 [°]	UINT 16		YO
302338	0921h	1	2° harmonic Ph. Angle VL2-N→AL2 [°]	UINT 16		YO
...	YO
302367	093Eh	1	30° harmonic Ph. Angle VL2-N→AL2 [°]	UINT 16		YO



302368	093Fh	1	31° harmonic Ph. Angle VL2-N→AL2 [°]	UINT 16		Y0
302369	0940h	1	1° harmonic Ph. Angle VL3-N→AL3 [°]	UINT 16		Y0
302370	0941h	1	2° harmonic Ph. Angle VL3-N→AL3 [°]	UINT 16		Y0
...			Y0
302399	095Eh	1	30° harmonic Ph. Angle VL3-N→AL3 [°]	UINT 16		Y0
302400	095Fh	1	31° harmonic Ph. Angle VL3-N→AL3 [°]	UINT 16		Y0

2.12 Modules programming parameter

2.12.1 Modules map

Table 2.12-1

Module Ref.	Description	Module acknowledgement	Module Name	Firmware compatibility
1	WM30 base provided with display, power supply, measuring inputs and optical front communication port		WM30 AV5	
2			WM30 AV6	
3			WM30 AV4	
4			WM30 AV7	
1b	WM40 base provided with display, power supply, measuring inputs and optical front communication port		WM40 AV5	
2b			WM40 AV6	
3b			WM40 AV4	
4b			WM40 AV7	
1c	WM20 base provided with display, power supply, measuring inputs and optical front communication port		WM20 AV5	
2c			WM20 AV6	
3c			WM20 AV4	
4c			WM20 AV7	
5	RS485 / RS232 port (Modbus RTU Protocol)	Manual (by means of keyboard) or via Modbus	M C 485 232	X0, Y0, Z0
6	RS485 / RS232 port with memory for data stamping	Automatic	M C 485 232 M	Y0
7	Ethernet (Modbus TCP/IP protocol)	Automatic	M C ETH	X1, Y0, Z0
8	Ethernet (Modbus TCP/IP & Bacnet protocol)	Automatic	M C BAC IP	X0, Y0, Z0
7b	Ethernet (Modbus TCP/IP protocol) with memory for data stamping	Automatic	M C ETH M	Y0
8b	Ethernet (Modbus TCP/IP & Bacnet protocol) with memory for data stamping	Automatic	M C BAC IP M	Y0
9	Analogue output (20 mADC)	Automatic	M O A2	X1, Y0
10	Analogue output (10 VDC)	Automatic	M O V2	X1, Y0
11	Relay output	Manual	M O R2	X0, Y0, Z0
12	Opto-Mos output	Manual	M O O2	X0, Y0, Z0
13	Digital inputs and Opto-Mos outputs	Automatic	M F I6 R4	Y0
14	Digital inputs and relay outputs	Automatic	M F I6 O6	Y0
16	Temperature + Process signal measurement (°C / °F)	Automatic	M A T P	Y0
17	Direct neutral current measurement + Temperature + Process signal measurement (°C / °F)	Automatic	M A T P N	Y0
18	Ethernet (Modbus TCP/IP protocol) RS 485 (Bacnet protocol)	Automatic	M C BAC MS	X8, Y5, Z0
18b	Ethernet (Modbus TCP/IP protocol) RS 485 (Bacnet protocol) with memory for data stamping	Automatic	M C BAC MS M	Y5
19	Ethernet/IP	Automatic	M C EI	X14, Y11
19b	Ethernet/IP with memory for data stamping	Automatic	M C EI M	Y11
20	Profibus	Automatic	M C PB	X21, Y17, Z0
20b	Profibus with memory for data stamping	Automatic	M C PB M	Y17

2.12.2 Base (Module Ref. 1, 2, 3 and 4)

MODBUS: read and write mode

Table 2.12-2

Modicom address	Physical address	Length (words)	VARIABLE ENG. UNIT	Data Format	Notes	Firmware compatibility
304097	1000h	1	Password	UINT 16	Minimum valid value: 0d Maximum valid value: 9999d	X0, Y0, Z0
304098	1001h	1	Electrical system selection	UINT 16	Value =0: 1P (1-phase 2-wire) Value =1: 2P (2-phase 3-wire) Value=2: 3P (3-phase 3-wire) Value=3: 3P2 (3-phase 2-wire) one current and 1-phase (L1) to neutral voltage measurement)	X0, Y0, Z0



					Value=4: 3P1 (3-phase 4-wire one current and 3-phase to neutral voltage measurements) Value=5: 3PN (default =3PN)	
304099	1002h	1	Application selection	UINT 16	Value=0: A Value=1: B Value=2: C Value=3: D Solar Value=4: E Industrial Value=5: F Advanced industrial Value=6: G Advanced industrial for power generation (Default =6)	X0, Y0
304100	1003h	1	Backlight colour	UINT 16	Colour selection of the Backlight 0 = Back_Off 1 = Back_White	X0
304100	1003h	1	Backlight colour	UINT 16	Colour selection of the backlight 0 = Back_Off (No timer) 1 = Back_White (Timer) 2 = Back_Blue (Timer) 3 = Backlight always OFF, when an alarm occurs it flashes from white to blue (No timer) 4 = Backlight always white, when an alarm occurs it flashes from white to blue (Timer) 5 = Backlight always blue, when an alarm occurs it flashes from blue to white (Timer) Note. Main colour: 1 s, second colour: 1 s. The alarm warning works as an OR logic. The alarm has always priority with respect to the backlight timer.	Y0
304101	1004h	1	Backlight mode	UINT 16	The timing backlight is programmable from 0 (always ON) to 255 minutes	X0, Y0, Z0
304102	1005h	1	Home page type	UINT 16	0 = line "2-3-4-5" with freely programmable system variables 1 = Preset Page	X0, Y0
304102	1005h	1	Home page type	UINT 16	0 = rotating page mode 1 to 14 = preset home page	Z0
304103	1006h	1	Home page - Line 2	UINT 16	Home page type = 0 and System ≠ 1P: 0=AN; 1=WΣ; 2=VARΣ; 3=VAΣ; 4=PFΣ; 5=frequency; other values=AN Home Page Type = 0 and System = 1P: 0=V1; 1=A1; 2=W1; 3=VAR1; 4=VA1; 5=PF1; 6=frequency; other values = V1 Home page type = 1 and System ≠ 1P: 0=empty; 1=VLN; 2=VLL; 3=A; 4=Hz/ASY; 5=VA; 6=VAR; 7=W; 8=PF; 9=THD_VLN; 10=THD_VLL; 11=THD_A (0÷11: preset pages) Home page type = 1 and System = 1P: 0, 1, 2, 3, 4 = page with V1, A1, Hz 5, 6, 7, 8 = page with VA, VAR1, W1, PF1 9, 10, 11 = page with THD_V1, THD_A1	X0
304103	1006h	1	Home page - Line 2	UINT 16	Home page type = 0 and System ≠ 1P: 0=AN; 1=WΣ; 2=VARΣ; 3=VAΣ; 4=PFΣ; 5=frequency; other values=AN Home Page Type = 0 and System = 1P: 0=V1; 1=A1; 2=W1; 3=VAR1; 4=VA1; 5=PF1; 6=frequency; other values = V1 Home page type = 1 and System ≠ 1P: 0=empty; 1=VLN; 2=VLL; 3=A; 4=Hz/ASY; 5=VA; 6=VAR; 7=W; 8=PF; 9=THD_VLN; 10=THD_VLL; 11=THD_A; 12=VLL+A (0÷12: preset pages) Home page type = 1 and System = 1P: 0 = empty 1, 2, 3, 4 = page with V1, A1, Hz 5, 6, 7, 8 = page with VA, VAR1, W1, PF1 9, 10, 11 = page with THD_V1, THD_A1 12 = empty	X8
304103	1006h	1	Home page - Line 2	UINT 16	Home page type = 0 and System ≠ 1P: 0=AN; 1=WΣ; 2=VARΣ; 3=VAΣ; 4=PFΣ;	X16

					<p>5=frequency; 6=AΣ other values=AN</p> <p>Home Page Type = 0 and System = 1P: 0=V1; 1=A1; 2=W1; 3=VAR1; 4=VA1; 5=PF1; 6=frequency; other values = V1</p> <p>Home page type = 1 and System \neq 1P: 0=empty; 1=VLN; 2=VLL; 3=AN+A; 4=Hz+ASY; 5=VA; 6=VAR; 7=W; 8=PF; 9=THD_VLN; 10=THD_VLL; 11=THD_A; 12=VLL+A; 13=AΣ+A (0:13: preset pages)</p> <p>Home page type = 1 and System = 1P: 0 = empty 1, 2, 3, 4 = page with V1, A1, Hz 5, 6, 7, 8 = page with VA, VAR1, W1, PF1 9, 10, 11 = page with THD_V1, THD_A1 12, 13 = empty</p>	
304103	1006h	1	Home page - Line 2	UINT 16	<p>Home page type = 0 and System \neq 1P: 0=AN; 1= WΣ; 2=VARΣ; 3=VAΣ; 4=PFΣ; 5=frequency; other values = AN</p> <p>Home page type = 0 and System = 1P: 0=V1; 1=A1; 2=W1; 3=VAR1; 4=VA1; 5=PF1; 6=frequency; other values=V1</p> <p>Home Page Type = 1 and System \neq 1P: 0=empty; 1=VLN; 2=VLL; 3=A; 4=Hz/ASY; 5=VA; 6=VAR; 7=W; 8=PF; 9=THD_VLN; 10=THD_VLL; 11=THD_A; 12=THD_VLN_EVEN; 13=THD_VLL_EVEN; 14=THD_A_EVEN; 15=THD_VLN_ODD; 16=THD_VLL_ODD; 17=THD_A_ODD; 18=K_FACTOR; 19=TDD_A; 20=EXT; (0:21: preset pages)</p> <p>Home page type = 1 and System = 1P: 0, 1, 2, 3, 4 = page with V1, A1, Hz 5, 6, 7, 8 = page with VA1, VAR1, W1, PF1 9, 10, 11 = page with THD_V1, THD A1 12, 13, 14 = page with THD_V1 EVEN, THD_A1 EVEN 15, 16, 17 = page with THD_V1 ODD, THD_A1 ODD 18 = page with K-Factor 1 19 = page with TDD_A1 20 = page with EXT</p>	Y0
304103	1006h	1	Home page - Line 2	UINT 16	<p>Home page type = 0 and System \neq 1P: 0=AN; 1= WΣ; 2=VARΣ; 3=VAΣ; 4=PFΣ; 5=frequency; other values = AN</p> <p>Home page type = 0 and System = 1P: 0=V1; 1=A1; 2=W1; 3=VAR1; 4=VA1; 5=PF1; 6=frequency; other values=V1</p> <p>Home Page Type = 1 and System \neq 1P: 0=empty; 1=VLN; 2=VLL; 3=A; 4=Hz/ASY; 5=VA; 6=VAR; 7=W; 8=PF; 9=THD_VLN; 10=THD_VLL; 11=THD_A; 12=THD_VLN_EVEN; 13=THD_VLL_EVEN; 14=THD_A_EVEN; 15=THD_VLN_ODD; 16=THD_VLL_ODD; 17=THD_A_ODD; 18=K_FACTOR; 19=TDD_A; 20=EXT 21=VLL+A (0:21: preset pages)</p> <p>Home page type = 1 and System = 1P: 0, 1, 2, 3, 4 = page with V1, A1, Hz 5, 6, 7, 8 = page with VA1, VAR1, W1, PF1 9, 10, 11 = page with THD_V1, THD A1 12, 13, 14 = page with THD_V1 EVEN, THD_A1 EVEN 15, 16, 17 = page with THD_V1 ODD, THD_A1 ODD 18 = page with K-Factor 1 19 = page with TDD_A1 20 = page with EXT 21 = empty</p>	Y5
304103	1006h	1	Home page - Line 2	UINT 16	<p>Home page type = 0 and System \neq 1P: 0=AN; 1= WΣ; 2=VARΣ; 3=VAΣ; 4=PFΣ; 5=frequency; 6= AΣ; other values = AN</p> <p>Home page type = 0 and System = 1P: 0=V1; 1=A1; 2=W1; 3=VAR1; 4=VA1; 5=PF1; 6=frequency; other values=V1</p>	Y13

					<p>Home Page Type = 1 and System ≠ 1P: 0=empty; 1=VLN; 2=VLL; 3=AN+A; 4=Hz/ASY; 5=VA; 6=VAR; 7=W; 8=PF; 9=THD_VLN; 10=THD_VLL; 11=THD_A; 12=THD_VLN_EVEN; 13=THD_VLL_EVEN; 14=THD_A_EVEN; 15=THD_VLN_ODD; 16=THD_VLL_ODD; 17=THD_A_ODD; 18=K_FACTOR; 19=TDD_A; 20=EXT; 21=VLL+A; 22= AΣ+A (0÷22: preset pages)</p> <p>Home page type = 1 and System = 1P: 0, 1, 2, 3, 4 = page with V1, A1, Hz 5, 6, 7, 8 = page with VA1, VAR1, W1, PF1 9, 10, 11 = page with THD_V1, THD A1 12, 13, 14 = page with THD_V1 EVEN, THD_A1 EVEN 15, 16, 17 = page with THD_V1 ODD, THD_A1 ODD 18 = page with K-Factor 1 19 = page with TDD_A1 20 = page with EXT 21, 22 = empty</p>	
304104	1007h	1	Home page - Line 3	UINT 16	<p>Home page type = 0 and System ≠ 1P: 0=AN; 1=WΣ; 2=VARΣ; 3=VAΣ; 4=PFΣ; 5=frequency; other values=AN</p> <p>Home page type = 0 and System = 1P: 0=V1; 1=A1; 2=W1; 3=VAR1; 4=VA1; 5=PF1</p>	X0, Y0
304105	1008h	1	Home page - Line 4	UINT 16	<p>Home page type = 0 and System ≠ 1P: 0=VL-LΣ; 1=AN; 2= WΣ; 3=VARΣ; 4=VAΣ; 5=PFΣ; 6=frequency</p> <p>Home page type = 0 and System = 1P: 0=V1; 1=A1; 2=W1; 3=VAR1; 4=VA1; 5=PF1; 6=frequency</p>	X0, Y0
304106	1009h	1	Home page - Line 5	UINT 16	<p>Home page type = 0 and System ≠ 1P: 0=VL-NΣ; 1=AN; 2= WΣ; 3=VARΣ; 4=VAΣ; 5=PFΣ; 6=frequency</p> <p>Home page type = 0 and System = 1P: 0=V1; 1=A1; 2=W1; 3=VAR1; 4=VA1; 5=PF1; 6=frequency</p>	X0, Y0
304107	100Ah	1	DMD - Calculation	UINT 16	<p>Selection of the DMD calculation mode Value=0: Fixed Value=1: Slide - only for WΣ and VAΣ</p>	X0, Y0
304108	100Bh	1	DMD - Time interval	UINT 16	<p>Value=0: 1 min Value=1: 5 min Value=2: 10 min Value=3: 15 min Value=4: 30 min Value=5: 60 min</p>	X0
304108	100Bh	1	DMD - Time interval	UINT 16	<p>Value=0: 1 min Value=1: 5 min Value=2: 10 min Value=3: 15 min Value=4: 20 min Value=5: 30 min Value=6: 60 min Value=7: 30 s</p>	X2, Y0, Z0 Y0
304109	100Ch	1	DMD - Synchronisation	UINT 16	<p>Synchronisation selection mode Value=0: OFF Value=1: Clock Value=2: Contact</p>	X0, Y0 Y0
304110	100Dh	1	LCD Bar-graph	UINT 16	<p>Value=0: Disabled Value=1: WΣ Value=2: VAΣ</p>	X0
304110	100Dh	1	LCD Bar graph	UINT 16	<p>Value=0: WΣ Value=1: VAΣ Value=2: Disabled</p>	X2, Y0
304111	100Eh	1	Optical port Address	UINT 16	Value=1	Y0
304112	100Fh	1	USART2_ModeSelection	UINT 16	Value=1	Y0
304113	1010h	1	(**) Optical port - baud rate selection	UINT 16	<p>Value=0: 9600 Value=1: 19200 Value=2: 38400 Value=3: 115200</p>	Y0, Z0
304114	1011h	1	(**) Optical port - parity selection	UINT 16	Value=0: No parity	Y0, Z0

					Value=1: Odd parity Value=2: Even parity	
304115	1012h	1	Optical port - bit Stop	UINT 16		Y0
304116	1013h	1	Factor K / K Factor selection	UINT 16	Value=0: Factor K Value=1: K-Factor	Y0
304121	1018h	2	CT - Current transformer ratio	32 bit IEEE 754	1.0 to 9999.0	X0, Y0, Z0
304123	101Ah	2	VT(PT) - Voltage transformer ratio	32 bit IEEE 754	1.0 to 9999.0	X0, Y0, Z0
304125	101Ch	2	Nominal installed power	32 bit IEEE 754	Value min = 1000 (1K) Value max = 9999000000 (9999M)	X0, Y0
304127	101Eh	2	Filter Span parameter	32 bit IEEE 754	Value min = 0.0 Value max = 100.0 (Disabled = 0.0)	X0, Y0, Z0
304129	1020h	2	Filter Coefficient	32 bit IEEE 754	Value min = 1.0 Value max = 256.0	X0, Y0, Z0
304131	1022h	2	Low V reference for bar-graph	32 bit IEEE 754		Y0
304133	1024h	2	High V reference for bar-graph	32 bit IEEE 754		Y0
304135	1026h	2	Low A reference for bar-graph	32 bit IEEE 754		Y0
304137	1028h	2	High A reference for bar-graph	32 bit IEEE 754		Y0
304139	102Ah	2	Low PF reference for bar-graph	32 bit IEEE 754		Y0
304141	102Ch	2	High PF reference for bar-graph	32 bit IEEE 754		Y0
304143	102Eh	2	Eddy (e) for K-Factor	32 bit IEEE 754	Min = 0.0	Y0
304145	1030h	2	Exponential constant (q) for K-Factor	32 bit IEEE 754	Min = 0.0	Y0
304147	1032h	2	Max. demand load current (IL) for TDD	32 bit IEEE 754	Min = 0.001	Y0
304149	1034h	2	Threshold current for Hours counter	32 bit IEEE 754	Min = 0.001A	Z0
304177	1050h	16	Virtual Alarm AL1 (LED 1)	Customized Base Alarm data structure	Refer to the Table 2.12-3	X0
304193	1060h	16	Virtual Alarm AL2 (LED 2)			X0
304209	1070h	16	Virtual Alarm AL3 (LED 3)			X0
304225	1080h	16	Virtual Alarm AL4 (LED 4)			X0
304177	1050h	16	Virtual Alarm AL1 (Alarm icon)	Customized Base Alarm data structure	Refer to the Table 2.12-3	Z0
304193	1060h	16	Virtual Alarm AL2 (Alarm icon)			Z0
305377	1500h	16	Virtual Alarm AL1 (LED 1)	Customized Advanced Alarm data structure	Refer to the Table 2.12-4	Y0
305393	1510h	16	Virtual Alarm AL2 (LED 1)			Y0
305409	1520h	16	Virtual Alarm AL3 (LED 1)			Y0
305425	1530h	16	Virtual Alarm AL4 (LED 1)			Y0
305441	1540h	16	Virtual Alarm AL5 (LED 2)			Y0
305457	1550h	16	Virtual Alarm AL6 (Led 2)			Y0
305473	1560h	16	Virtual Alarm AL7 (Led 2)			Y0
305489	1570h	16	Virtual Alarm AL8 (Led 2)			Y0
305505	1580h	16	Virtual Alarm AL9 (Led 3)			Y0
305521	1590h	16	Virtual Alarm AL10 (Led 3)			Y0
305537	15A0h	16	Virtual Alarm AL11 (Led 3)			Y0
305553	15B0h	16	Virtual Alarm AL12 (Led 3)			Y0
305569	15C0h	16	Virtual Alarm AL13 (Led 4)			Y0
305585	15D0h	16	Virtual Alarm AL14 (Led 4)			Y0
305601	15E0h	16	Virtual Alarm AL15 (Led 4)			Y0
305617	15F0h	16	Virtual Alarm AL16 (Led 4)			Y0

(*) The maximum power being measured cannot exceed 210 MW. If the currents and/or voltages being measured exceed their maximum limits the display shows the "EEEE" error message. For MID compliant applications the maximum power being measured is 25 MW.

(**) The values are updated only after sending the "update optical communication setting" command or switching off and on the instrument.

Base module - Virtual Alarm configuration parameters

Table 2.12-3

Modicom address	Physical address	Length (words)	VARIABLE ENG. UNIT	Data Format	Notes	Firmware compatibility
Block address +0	Block address +0	1	Alarm N - Enabling	UINT 16	Value=1: alarm N enabled Value=0: alarm N disabled All other values are considered as value=0	X0, Z0
Block address +1	Block address +1	1	Alarm N - Variable type to be linked to	UINT 16	Refer to the Code Variable List (2.12.12)	X0, Z0
Block address +2	Block address +2	1	Alarm N - Delay ON activation (s)	UINT 16	Value min=0 Value max=3600 If the set value exceeds the allowed range, the instrument automatically sets the value to 0	X0, Z0
Block address +3	Block address +3	2	Alarm N - Set point 1	32 bit IEEE 754	Value min = -9999M Value max = 9999M If the set value exceeds the allowed range, the instrument automatically sets the value to 0.000	X0, Z0

Block address +5	Block address +5	2	Alarm N – Set point 2	32 bit IEEE 754	Value min = -9999M Value max = 9999M If the set value exceeds the allowed range, the instrument automatically sets the value to 0.000	X0, Z0
Block address +7	Block address +7	9	Reserved			

Advanced Base module - Virtual Alarm configuration parameters

Table 2.12-4

Modicom address	Physical address	Length (words)	VARIABLE ENG. UNIT	Data Format	Notes	Firmware compatibility
Block address +0	Block address +0	1	Alarm N - Enabling	UINT 16	Value=1: alarm N enabled Value=0: alarm N disabled All other values are considered as value=0	Y0
Block address +1	Block address +1	1	Alarm N - Variable type to be linked to	UINT 16	Refer to the Code Variable List (2.12.12)	Y0
Block address +2	Block address +2	1	Alarm type	UINT 16	Value=0: UP monitoring Value=1: DOWN monitoring Value=2: IN monitoring Value=3: OUT monitoring	Y0
Block address +3	Block address +3	1	Latch function	UINT 16	Value=0: OFF Value=1: ON	Y0
Block address +4	Block address +4	1	Alarm condition monitoring start	UINT 16	Value=0: the alarm monitoring starts at power ON Value=1: the alarm monitoring starts with no alarm condition	Y0
Block address +5	Block address +5	1	Alarm N - Delay ON activation (s)	UINT 16	Value min 0 Value max=3600 If the set value exceeds the allowed range, the instrument automatically sets the value to 0	Y0
Block address +6	Block address +6	1	Physical output linked to	UINT 16	Value=0: Virtual Value=1÷8 (physical output)	Y0
Block address +7	Block address +7	1	Physical output - Logic	UINT 16	Value=0: OR Value=1: AND	Y0
Block address +8	Block address +8	2	Alarm N – Set point 1	32 bit IEEE 754	Value min = -9999M Value max = 9999M If the set value exceeds the allowed range, the instrument automatically sets the value to 0.000	Y0
Block address +10	Block address +10	2	Alarm N – Set point 2	32 bit IEEE 754	Value min = -9999M Value max = 9999M If the set value exceeds the allowed range, the instrument automatically sets the value to 0.000	Y0
Block address +12	Block address +12	4	Reserved			Y0

2.12.3 RS485 – RS232 (Module Ref. 5 and Module Ref. 6)

MODBUS: Read and write mode

Table 2.12-5

Modicom address	Physical address	Length (words)	VARIABLE ENG. UNIT	Data Format	Notes	Firmware compatibility
304353	1100h	1	Data Base system setup (only for MC485232M – Module ref. 6)	UINT 16	Bit 0: DB DMD/MAX/MIN enabled Value=0: NO Value=1: YES Bit 1: Event enabled Value=0: NO Value=1: YES Bit 2: Load profiling enabled Value=0: NO Value=1: YES Family events enabled Value=0: NO Value=1: YES Bit 6: Alarm Bit 7: Digital Input Bit 8: Digital Output	Y0

					Bit 9: Max Bit 10: Min Bit 11: DMD Max Bit 12: Reset Counters Bit 13: Reset Min/Max/DMD/MaxDMD Bit 14: Reset DB DB DMD has the same integration time as NormalDMD	
304354	1101h	1	Load profiling - Time interval selection (only for MC485232M – Module ref. 6)	UINT 16	Value=0: 1 min Value=1: 5 min Value=2: 10 min Value=3: 15 min Value=4: 20 min Value=5: 30 min Value=6: 60 min	Y0
304355	1102h	1	Load profiling – Variable selection (only for MC485232M – Module ref. 6)	UINT 16	Value=0: Wdmd Value=1: VAdmd	Y0
304356	1103h	1	Clock format	UINT 16	0=24h/12h 1=AM-PM	X0, Y0
304357	1104h	1	Clock daylight-saving	UINT 16	Value=0: NO Value=1: YES	X0, Y0
304357	1104h	1	Clock daylight-saving/Clock sync. via digital input	UINT 16	Daylight Bit1: Value=0: NO; Value=1: YES Sync. Bit2: Value=0: NO; Value=1: YES	Y0
304358	1105h	1	(*) Clock calendar: Year	UINT 16	2009÷2099	X0, Y0
304359	1106h	1	(*) Clock calendar: Month	UINT 16	1÷12	X0, Y0
304360	1107h	1	(*) Clock calendar: Day	UINT 16	1÷31	X0, Y0
304361	1108h	1	(*) Clock: Hour	UINT 16	0÷23	X0, Y0
304362	1109h	1	(*) Clock: Minutes	UINT 16	0÷59	X0, Y0
304363	110Ah	1	(*) Clock: Seconds	UINT 16	0÷59	X0, Y0
304364	110Bh	1	Daylight-saving: month in which to increase the hour (+1H)	UINT 16	1÷12	X0, Y0
304365	110Ch	1	Daylight-saving: Sunday in which to increase the hour (+1H)	UINT 16	0÷4 (0= last Sunday of the month)	X0, Y0
304366	110Dh	1	Daylight-saving: hour in which to increase the hour (+1H)	UINT 16	0÷23 (24h format only)	X0, Y0
304367	110Eh	1	Daylight-saving: month in which to decrease the hour (-1H)	UINT 16	1÷12	X0, Y0
304368	110Fh	1	Daylight-saving: Sunday in which to decrease the hour (-1H)	UINT 16	0÷4 (0= last Sunday of the month)	X0, Y0
304369	1110h	1	Daylight-saving: hour in which to decrease the hour (-1H)	UINT 16	0÷23 (24h format only)	X0, Y0
304370	1111h	1	DMD Variable 1	INT 16	Refer to the Code Variable List (2.12.11) If value = 0xFF: disabled It is possible to modify this area only after sending the 3057h command, which stops and resets the DB DMD System. Send the 3058h command to unlock this area and restart the DB DMD system.	Y0
304371	1112h	1	DMD Variable 2	INT 16		Y0
304372	1113h	1	DMD Variable 3	INT 16		Y0
304373	1114h	1	DMD Variable 4	INT 16		Y0
304374	1115h	1	DMD Variable 5	INT 16		Y0
304375	1116h	1	DMD Variable 6	INT 16		Y0
304376	1117h	1	DMD Variable 7	INT 16		Y0
304377	1118h	1	DMD Variable 8	INT 16		Y0
304378	1119h	1	DMD Variable 9	INT 16		Y0
304379	111Ah	1	DMD Variable 10	INT 16		Y0
304380	111Bh	1	DMD Variable 11	INT 16		Y0
304381	111Ch	1	DMD Variable 12	INT 16		Y0
304382	111Dh	1	DMD Variable 13	INT 16		Y0
304383	111Eh	1	DMD Variable 14	INT 16		Y0
304384	111Fh	1	DMD Variable 15	INT 16		Y0
304385	1120h	1	DMD Variable 16	INT 16		Y0
304386	1121h	1	DMD Variable 17	INT 16		Y0
304387	1122h	1	DMD Variable 18	INT 16		Y0
304388	1123h	1	DMD Variable 19	INT 16		Y0
304389	1124h	1	DMD Variable 20	INT 16		Y0
304390	1125h	1	Calculation type enabling	INT 16	Value=0: NO Value=1: YES Bit 0: DMD Bit 1: MAX Bit 2: MIN It is possible to modify this area only after sending the 3057h command, which stops and resets the DB DMD System. Send the 3058h command to unlock this area and restart the DB DMD system.	Y0
304391	1126h	1	Number of enabled variables	INT 16	Read only!	Y0
304401	1130h	1	(**) RS485 instrument address selection	UINT 16	Value min = 1 Value max = 247 If the set value exceeds the allowed range, the instrument automatically sets	X0, Z0

					the value to 1	
304402	1131h	1	(**) RS485 baud rate selection	UINT 16	Value=0: 9600 Value=1: 19200 Value=2: 38400 Value=3: 115200 All other values are considered as value=0	X0, Z0
304403	1132h	1	(**) RS485 parity selection	UINT 16	Value=0: No parity Value=1: Odd parity Value=2: Even parity All other values are considered as value=0	X0, Z0
3041404	1133h	1	(**) RS485 Bit Stop	UINT 16		Y0
3041405	1134h	1	DB DMD - Time interval selection minute (only for MC485232M – Module ref. 6)	UINT 16	Value min = 1 Value max = 60	Y8

(*) The values are updated only after sending the “update clock” command.

(**) The values are updated only after sending the “update serial communication setting” command or switching off and on the instrument.

2.12.4 Ethernet / Bacnet (See 2.12.1 Table: Module Ref. 7, Module Ref. 8 and Module Ref. 18)

MODBUS: Read and write mode

Table 2.12-6

Modicom address	Physical address	Length (words)	VARIABLE ENG. UNIT	Data Format	Notes	Firmware compatibility
304353	1100h	1	Data Base system setup (only for MODULE WITH MEMORY)	UINT 16	Bit15÷Bit0 Bit 0: DB DMD/MAX/MIN Enabling Value=0: NO Value=1: YES Bit 1: Event Enable Value=0: NO Value=1: YES Bit 2: Load profiling Enabling Value=0: NO Value=1: YES Family events Enabling Value=0: NO Value=1: YES Bit 6: Alarm Bit 7: Digital Input Bit 8: Digital Output Bit 9: Max Bit 10: Min Bit 11: DMD Max Bit 12: Reset Counters Bit 13: Reset Min/Max/DMD/MaxDMD Bit 14: Reset DB DB DMD has the same integration time as NormalDMD	Y0
304354	1101h	1	Load profiling - Time interval selection (only for MODULE WITH MEMORY)	UINT 16	Value=0: 1 min Value=1: 5 min Value=2: 10 min Value=3: 15 min Value=4: 20 min Value=5: 30 min Value=6: 60 min	Y0
304355	1102h	1	Load profiling – Variable selection (only for MODULE WITH MEMORY)	UINT 16	Value=0: Wdmd Value=1: VAdmd	Y0
304356	1103h	1	Clock format	UINT 16	0=24h/12h ; 1=AM-PM	X0, Y0
304357	1104h	1	Clock daylight-saving	UINT 16	Value=0: NO Value=1: YES	X0, Y0
304357	1104h	1	Clock daylight-saving/Clock sync. via digital input	UINT 16	Daylight Bit1: Value=0: NO; Value=1: YES; Sync. Bit2: Value=0: NO; Value=1: YES	Y0
304358	1105h	1	(*) Clock calendar: Year	UINT 16	2009÷2099	X0, Y0
304359	1106h	1	(*) Clock calendar: Month	UINT 16	1÷12	X0, Y0
304360	1107h	1	(*) Clock calendar: Day	UINT 16	1÷31	X0, Y0
304361	1108h	1	(*) Clock: hour	UINT 16	0÷23	X0, Y0
304362	1109h	1	(*) Clock: minutes	UINT 16	0÷59	X0, Y0
304363	110Ah	1	(*) Clock: seconds	UINT 16	0÷59	X0, Y0
304364	110Bh	1	Daylight-saving: month in which to increase the hour (+1H)	UINT 16	1÷12	X0, Y0
304365	110Ch	1	Daylight-saving: Sunday in which to increase the hour (+1H)	UINT 16	0÷4 (0= last Sunday of the month)	X0, Y0
304366	110Dh	1	Daylight-saving: hour in which to increase the hour (+1H)	UINT 16	0÷23 (24h format only)	X0, Y0
304367	110Eh	1	Daylight-saving: month in which to	UINT 16	1÷12	X0, Y0

			decrease the hour (-1H)			
304368	110Fh	1	Daylight-saving: Sunday in which to decrease the hour (-1H)	UINT 16	0÷4 (0= last Sunday of the month)	X0, Y0
304369	1110h	1	Daylight-saving: hour in which to decrease the hour (-1H)	UINT 16	0÷23 (24h format only)	X0, Y0
304370	1111h	1	DMD Variable 1	INT 16	<p>Refer to the Code Variable List (2.12.11)</p> <p>If value = 0xFF: disabled</p> <p>It is possible to modify this area only after sending the 3057h command, which stops and resets the DB DMD System.</p> <p>Send the 3058h command to unlock this area and restart the DB DMD system.</p> <p>(only for MODULE WITH MEMORY)</p>	Y0
304371	1112h	1	DMD Variable 2	INT 16		Y0
304372	1113h	1	DMD Variable 3	INT 16		Y0
304373	1114h	1	DMD Variable 4	INT 16		Y0
304374	1115h	1	DMD Variable 5	INT 16		Y0
304375	1116h	1	DMD Variable 6	INT 16		Y0
304376	1117h	1	DMD Variable 7	INT 16		Y0
304377	1118h	1	DMD Variable 8	INT 16		Y0
304378	1119h	1	DMD Variable 9	INT 16		Y0
304379	111Ah	1	DMD Variable 10	INT 16		Y0
304380	111Bh	1	DMD Variable 11	INT 16		Y0
304381	111Ch	1	DMD Variable 12	INT 16		Y0
304382	111Dh	1	DMD Variable 13	INT 16		Y0
304383	111Eh	1	DMD Variable 14	INT 16		Y0
304384	111Fh	1	DMD Variable 15	INT 16		Y0
304385	1120h	1	DMD Variable 16	INT 16		Y0
304386	1121h	1	DMD Variable 17	INT 16		Y0
304387	1122h	1	DMD Variable 18	INT 16		Y0
304388	1123h	1	DMD Variable 19	INT 16		Y0
304389	1124h	1	DMD Variable 20	INT 16		Y0
304390	1125h	1	Calculation type enabling	INT 16	<p>Value=0: NO Value=1: YES</p> <p>Bit 0: DMD Bit 1: MAX Bit 2: MIN</p> <p>It is possible to modify this area only after sending the 3057h command, which stops and resets the DB DMD system.</p> <p>Send the 3058h command to unlock this area and restart the DB DMD system.</p> <p>(only for MODULE WITH MEMORY)</p>	Y0
304391	1126h	1	Number of enabled variables	INT 16	Read only !	Y0
3041405	1134h	1	DB DMD - Time interval selection minute (only for Module with memory)	UINT 16	Value min = 1 Value max = 60	Y8
304433	1150h	1	IP Address (A.B.C.D)	UINT 16	Value min = 0 Value max = 255 All the other values are considered as value=255	X0, Y0, Z0
304434	1151h	1	IP Address (A.B.C.D)	UINT 16	Value min = 0 Value max = 255 All the other values are considered as value=255	X0, Y0, Z0
304435	1152h	1	IP Address (A.B.C.D)	UINT 16	Value min = 0 Value max = 255 All the other values are considered as value=255	X0, Y0, Z0
304436	1153h	1	IP Address (A.B.C.D)	UINT 16	Value min = 0 Value max = 255 All the other values are considered as value=255	X0, Y0, Z0
304437	1154h	1	Subnet mask (A.B.C.D)	UINT 16	Value min = 0 Value max = 255 All the other values are considered as value=255	X0, Y0, Z0
304438	1155h	1	Subnet mask (A.B.C.D)	UINT 16	Value min = 0 Value max = 255 All the other values are considered as value=255	X0, Y0, Z0
304439	1156h	1	Subnet mask (A.B.C.D)	UINT 16	Value min = 0 Value max = 255 All the other values are considered as value=255	X0, Y0, Z0
304440	1157h	1	Subnet mask (A.B.C.D)	UINT 16	Value min = 0 Value max = 255 All the other values are considered as value=255	X0, Y0, Z0
304441	1158h	1	Default Gateway (A.B.C.D)	UINT 16	Value min = 0 Value max = 255	X0, Y0, Z0

					All the other values are considered as value=255	
304442	1159h	1	Default Gateway (A.B.C.D)	UINT 16	Value min = 0 Value max = 255 All other values are considered as value=255	X0, Y0, Z0
304443	115Ah	1	Default Gateway (A.B.C.D)	UINT 16	Value min = 0 Value max = 255 All the other values are considered as value=255	X0, Y0, Z0
304444	115Bh	1	Default Gateway (A.B.C.D)	UINT 16	Value min = 0 Value max = 255 All the other values are considered as value=255	X0, Y0, Z0
304445	115Ch	1	Modbus TCP/IP port	UINT 16	Value min = 1 Value max = 9999 (default = 502)	X0, Y0, Z0
304446	115Dh	1	Bacnet Port (only for MC BAC IP or MC BAC IP M)	UINT 16	default = 0xBAC0	X0, Y0, Z0
304447	115Eh	1	Bacnet Device Instance Number (LSW) (only for BACNET MODULE)	UINT 16	Value min = 0 Value max = 65535	X0, Y0, Z0
304448	115Fh	1	Bacnet Device Instance Number (MSW) (only for BACNET MODULE)	UINT 16	Value min = 0 Value max = 65535	X0, Y0, Z0
304449	1160h	1	Update Ethernet	UINT 16	Value min = 0 Value max = 1 (when the configuration is changed)	X0, Y0, Z0
304450	1161h	1	Baud Rate (only for MC BAC MS)	UINT 16	Value=0: 9600 Value=1: 19200 Value=2: 38400 Default: 9600	X8, Y5
304450	1161h	1	Baud Rate (only for MC BAC MS)	UINT 16	Value=0: 9600 Value=1: 19200 Value=2: 38400 Value=3: 76800 Default: 9600	X15, Y11, Z0
304451	1162h	1	MAX_INFO_FRAMES (only for MC BAC MS)	UINT 16	Default Value: 1	X8, Y5, Z0
304452	1163h	1	MAX_MASTER (only for MC BAC MS)	UINT 16	Default: 127, Range 0-127	X8, Y5, Z0
304453	1164h	1	MAC-Address (only for MC BAC MS)	UINT 16	Range 0-127	X8, Y5, Z0
304454	1165h	1	ACD (address conflict detect) (only for MC EI)	UINT 16	Value=0: NO Value=1: YES	X14, Y11
304456	1167h	1	Foreign Device Enable (only for MC BAC IP)	UINT 16	Value=0: NO Value=1: YES	X17, Y14, Z0
304457	1168h	1	Ip address BBMD (A.B.C.D) (only for MC BAC IP)	UINT 16	Value min = 0 Value max = 255 All the other values are considered as value=255	X17, Y14, Z0
304458	1169h	1	Ip address BBMD (A.B.C.D) (only for MC BAC IP)	UINT 16	Value min = 0 Value max = 255 All the other values are considered as value=255	X17, Y14, Z0
304459	116Ah	1	Ip address BBMD (A.B.C.D) (only for MC BAC IP)	UINT 16	Value min = 0 Value max = 255 All the other values are considered as value=255	X17, Y14, Z0
304460	116Bh	1	Ip address BBMD (A.B.C.D) (only for MC BAC IP)	UINT 16	Value min = 0 Value max = 255 All the other values are considered as value=255	X17, Y14, Z0
304461	116Ch	1	UDP Port (only for MC BAC IP)	UINT 16	Value min = 0x1 Value max = 0xFFFF (default = 0xBAC0)	X17, Y14, Z0
304462	116Dh	1	Re-register time (s) (only for MC BAC IP)	UINT 16	Value min = 1 Value max = 60	X17, Y14, Z0

(*) The values are updated only after sending the "update clock" command.

(**)Note. To activate the new configuration of the ethernet interface it is necessary to send the "updating of Ethernet configuration" command (refer to 2.18.25) or switch off and on the instrument.

2.12.5 Analogue output (Module Ref. 9 and Module Ref. 10)

MODBUS: Read and write mode

Table 2.12-7

Modicom address	Physical address	Length (words)	VARIABLE ENG. UNIT	Data Format	Notes	Firmware compatibility
304609	1200h	16	Analogue output A0: parameters configuration	Customized data structure	Refer to the Table 2.12-8	X0, Y0



304625	1210h	16	Analogue output A1: parameters configuration	Customized data structure		X0, Y0
304641	1220h	16	Analogue output A2: parameters configuration	Customized data structure		Y0
304657	1230h	16	Analogue output A3: parameters configuration	Customized data structure		Y0

Analogue output configuration parameters

Table 2.12-8

Modicom address	Physical address	Length (words)	VARIABLE ENG. UNIT	Data Format	Notes	Firmware compatibility
Block address +0	Block address +0	1	Type of the variable that is linked to the N analogue output	UINT 16	Refer to the Code Variable List (2.12.11)	X0, Y0
Block address +1	Block address +1	2	Minimum electric value of the N analogue output	32 bit IEEE 754	Value min = -9999M Value max = 9999M (Value min = 0.0 for X1 and X0)	X2, Y0
Block address +3	Block address +3	2	Maximum electric value of the N analogue output	32 bit IEEE 754		
Block address +5	Block address +5	2	Minimum output value of the N analogue output	32 bit IEEE 754	Value min = 0.0 Value max = 100.0	X0, Y0
Block address +7	Block address +7	2	Maximum output value of the N analogue output	32 bit IEEE 754		
Block address +9	Block address +9	7	<i>Reserved</i>			X0, Y0

2.12.6 Relay / Opto-Mos output (Module Ref. 11 and Module Ref. 12)

MODBUS: Read and write mode

Table 2.12-9

Modicom address	Physical address	Length (words)	VARIABLE ENG. UNIT	Data Format	Notes	Firmware compatibility
304865	1300h	1	Digital output channel 1: enabling	UINT16	0=Remote; 1=Alarm; 2= Pulse	X0, Y0, Z0
304866	1301h	1	Digital output channel 1: output working mode	UINT16	0=NO; 1=NC (only if selected "Alarm" type)	X0, Y0, Z0
304867	1302h	1	Digital output channel 1: linked alarm	UINT16	0=AL1; 1=AL2; 2=AL3; 3=AL4 (only if selected "Alarm" type)	X0, Z0
304868	1303h	1	Channel 1: linked counter variable	UINT16	0=Total KWh+ 1=Total Kvarh+ 2=Total KWh- 3=Total Kvarh- 4=Partial KWh+ 5= Partial Kvarh+ 6= Partial KWh- 7= Partial Kvarh-	X0, Y0
304868	1303h	1	Channel 1: linked counter variable	UINT16	0=Total KWh+ 1=Total Kvarh+ 2=Total KWh- 3=Total Kvarh-	Z0
304869	1304h	2	Digital output channel 1: pulse	32 bit IEEE 754	Pulse weight (KWh/pulse or Kvarh/pulse) Value min = 0.001 Value max = 9999.9	X0, Y0, Z0
304871	1306h	1	Digital output channel 2: enabling	UINT16	0=Remote; 1=Alarm; 2= Pulse	X0, Y0, Z0
304872	1307h	1	Digital output channel 2: output working mode	UINT16	0=NO; 1=NC (only if selected "Alarm" type)	X0, Y0, Z0
304873	1308h	1	Digital output channel 2: linked alarm	UINT16	0=AL1; 1=AL2; 2=AL3; 3=AL4 (only if selected "Alarm" type)	X0, Z0
304874	1309h	1	Channel 2: linked counter variable	UINT16	0=Total KWh+ 1=Total Kvarh+ 2=Total KWh- 3=Total Kvarh- 4=Partial KWh+ 5= Partial Kvarh+ 6= Partial KWh- 7= Partial Kvarh-	X0, Y0
304874	1309h	1	Channel 2: linked counter variable	UINT16	0=Total KWh+ 1=Total Kvarh+ 2=Total KWh- 3=Total Kvarh-	Z0
304875	130Ah	2	Digital output channel 2: pulse	32 bit IEEE 754	Pulse weight (KWh/pulse or Kvarh/pulse) Value min = 0.001 Value max = 9999.0	X0, Y0, Z0

2.12.7 Digital Inputs and Outputs (Module Ref. 13 and Module Ref. 14)

MODBUS: Read and write mode

Table 2.12-10

Modicom address	Physical address	Length (words)	VARIABLE ENG. UNIT	Data Format	Notes	Firmware compatibility
304881	1310h	16	Digital output O3: parameters configuration	Customized data structure		Y0
304897	1320h	16	Digital output O4: parameters configuration	Customized data structure		Y0
304913	1330h	16	Digital output O5 configuration parameters	Customized data structure		Y0
304929	1340h	16	Digital output O6 configuration parameters	Customized data structure		Y0
304945	1350h	16	Digital output O7 configuration parameters	Customized data structure	Only for M F I6 O6 – module ref 14	Y0
304961	1360h	16	Digital output O8 configuration parameters	Customized data structure	Only for M F I6 O6 – module ref 14	Y0
304993	1380h	16	Digital input I1 parameters configuration	Customized data structure		Y0
305009	1390h	16	Digital input I2 parameters configuration	Customized data structure		Y0
305025	13A0h	16	Digital input I3 parameters configuration	Customized data structure		Y0
305041	13B0h	16	Digital input I4 parameters configuration	Customized data structure		Y0
305057	13C0h	16	Digital input I5 parameters configuration	Customized data structure		Y0
305073	13D0h	16	Digital input I6 parameters configuration	Customized data structure		Y0

Digital output parameters configuration

Table 2.12-11

Modicom address	Physical address	Length (words)	VARIABLE ENG. UNIT	Data Format	Notes	Firmware compatibility
Block address +0	Block address +0	1	Digital output: enabling	UINT16	0=Remote 1=Alarm 2= Pulse (Only for M F I6 O6 – module ref 14)	Y4
Block address +1	Block address +1	1	Digital output: output working mode	UINT16	0=NO; 1=NC (only if selected “Alarm” type)	Y0
Block address +2	Block address +2	1	Counter: linked counter variable	UINT16	0=Total KWh+ 1=Total Kvarh+ 2=Total KWh- 3=Total Kvarh- 4=Partial KWh+ 5= Partial Kvarh+ 6= Partial KWh- 7= Partial Kvarh-	Y0
Block address +3	Block address +3	2	Digital output: pulse	32 bit IEEE 754	Pulse weight (KWh/pulse or Kvarh/pulse) Value min = 0.001 Value max = 9999.0	Y0
Block address +7	Block address +7	10	Reserved			Y0

Digital input parameters configuration

Table 2.12-12

Modicom address	Physical address	Length (words)	VARIABLE ENG. UNIT	Data Format	Notes	Firmware compatibility
Block address +0	Block address +0	1	Digital input: function	UINT 16	Value=0: Remote input channel status (1) Value=1: Tariff change (2) Value=2: Water, gas, remote heating (3) Value=3: Remote alarm reset (4) Value=4: Trip counter of protection (5) Value=5: Synch (dmd) (6) Value=6: Energy counting (7)	Y0
Block address +1	Block address +1	1	Reserved	UINT 16		Y0
Block address +2	Block address +2	1	Digital input: totalizator type	UINT 16	Value=0: Gas Value=1: Cold H2O Value=2: Hot H2O Value=3: Remote heating Only in case of “Water, gas and remote heating (3)”	Y0

Block address +4	Block address +4	2	Digital input: pulse	32 bit IEEE 754	Pulse weight (KWh/pulse or KVarh/pulse) Value min = 0.001 Value max = 9999.0 Only in case of "Water, gas and remote heating" or "Energy counting"	Y0
Block address +6	Block address +6	10	Reserved			Y0

Note: every digital input can be configured according to the following table.

Function	Note	Digital input																																					
		1	2	3	4	5	6																																
Synch (dmd)	At each status change from OFF(1) to ON(0)	YES																																					
Tariff change	<table border="1"> <thead> <tr> <th>Current Tariff</th> <th>Digital CH 1</th> <th>Digital CH 2</th> <th>Digital CH 3</th> </tr> </thead> <tbody> <tr> <td>Tariff 1</td> <td>0</td> <td>0</td> <td>0</td> </tr> <tr> <td>Tariff 2</td> <td>1</td> <td>0</td> <td>0</td> </tr> <tr> <td>Tariff 3</td> <td>0</td> <td>1</td> <td>0</td> </tr> <tr> <td>Tariff 4</td> <td>1</td> <td>1</td> <td>0</td> </tr> <tr> <td>Tariff 5</td> <td>0</td> <td>0</td> <td>1</td> </tr> <tr> <td>Tariff 6</td> <td>1</td> <td>0</td> <td>1</td> </tr> <tr> <td>(Default Tariff)</td> <td>X</td> <td>1</td> <td>1</td> </tr> </tbody> </table>	Current Tariff	Digital CH 1	Digital CH 2	Digital CH 3	Tariff 1	0	0	0	Tariff 2	1	0	0	Tariff 3	0	1	0	Tariff 4	1	1	0	Tariff 5	0	0	1	Tariff 6	1	0	1	(Default Tariff)	X	1	1	YES	YES	YES			
		Current Tariff	Digital CH 1	Digital CH 2	Digital CH 3																																		
		Tariff 1	0	0	0																																		
		Tariff 2	1	0	0																																		
		Tariff 3	0	1	0																																		
		Tariff 4	1	1	0																																		
		Tariff 5	0	0	1																																		
		Tariff 6	1	0	1																																		
(Default Tariff)	X	1	1																																				
In case of incoherent programming the system uses default tariff																																							
Hot Water	The digital input ch 4 is joined only with the C-1 counter				YES	YES	YES																																
Cold Water	The digital input ch 5 is joined only with the C-2 counter				YES	YES	YES																																
Gas	The digital input ch 6 is joined only with the C-3 counter				YES	YES	YES																																
Remote heating					YES	YES	YES																																
Remote alarm reset	At each status change from OFF(1) to ON(0)				YES																																		
Trip counter of protection	The digital input ch 4 is joined only with the C-1 counter				YES																																		
Remote input channel status		YES	YES	YES	YES	YES	YES																																
kWh counting (-)				YES																																			
kWh counting (+)				YES																																			
kvarh counting (+)						YES																																	

MODBUS: Read and write mode

Table 2.12-13

Modicom address	Physical address	Length (words)	VARIABLE ENG. UNIT	Data Format	Notes	Firmware compatibility
305121	1400h	1	(*) Tariff from clock/input	UINT16	Value=0: disabled Value=1: Tariff selection by clock Value=2: Tariff selection by digital inputs	Y0
305121	1400h	1	(*) Tariff from clock/input/command	UINT16	Value=0: disabled Value=1: Tariff selection by clock Value=2: Tariff selection by digital inputs Value=3: Tariff selection by default value (modbus Physical address 143Fh)	Y17
305122	1401h	1	Working days	UINT16	Bit value: 1, working day Bit value: 0, non-working day Bit position (LSB concept) 0: Sunday 1: Monday 2: Tuesday 3: Wednesday 4: Thursday 5: Friday 6: Saturday	Y0
305123	1402h	1	Period 1: start	UINT16	Format: mmdd Value < 101: disabled	Y0
305124	1403h	1	Period 1: stop	UINT16		Y0
305125	1404h	1	Period 2: start	UINT16		Y0
305126	1405h	1	Period 2: stop	UINT16		Y0
305127	1406h	1	Time Slot 1 (Period 1): start	UINT16	Format: hhmm (24h format)	Y0
305128	1407h	1	Time Slot 1 (Period 1): stop	UINT16	Format: hhmm (24h format)	Y0
305129	1408h		Linked tariff: Time Slot 1 - Period 1	UINT16	Value=0: tariff 1; Value=1: tariff 2; Value=2: tariff 3; Value=3: tariff 4; Value=4: tariff 5; Value=5: tariff 6; Value=6: disabled	Y0
305130	1409h	1	Time Slot 1 (Period 2): start	UINT16	The format is hhmm (24h format)	Y0
305131	140Ah	1	Time Slot 1 (Period 2): stop	UINT16	The format is hhmm (24h format)	Y0
305132	140Bh		Linked tariff: Time Slot 1 - Period 2	UINT16	Value=0: tariff 1; Value=1: tariff 2; Value=2: tariff 3; Value=3: tariff 4; Value=4: tariff 5; Value=5: tariff 6; Value=6: disabled	Y0
305133	140Ch	1	Time Slot 2 (Period 1): start	UINT16	Format: hhmm (24h format)	Y0
305134	140Dh	1	Time Slot 2 (Period 1): stop	UINT16	Format: hhmm (24h format)	Y0

305135	140Eh		Linked tariff: Time Slot 2 - Period 1	UINT16	Value=0: tariff 1; Value=1: tariff 2; Value=2: tariff 3; Value=3: tariff 4; Value=4: tariff 5; Value=5: tariff 6; Value=6: disabled	YO
305136	140Fh	1	Time Slot 2 (Period 2): start	UINT16	Format: hhmm (24h format)	YO
305137	1410h	1	Time Slot 2 (Period 2): stop	UINT16	Format: hhmm (24h format)	YO
305138	1411h		Linked tariff: Time Slot 2 - Period 2	UINT16	Value=0: tariff 1; Value=1: tariff 2; Value=2: tariff 3; Value=3: tariff 4; Value=4: tariff 5; Value=5: tariff 6; Value=6: disabled	YO
305139	1412h	1	Time Slot 3 (Period 1): start	UINT16	Format: hhmm (24h format)	YO
305140	1413h	1	Time Slot 3 (Period 1): stop	UINT16	Format: hhmm (24h format)	YO
305141	1414h		Linked tariff: Time Slot 3 - Period 1	UINT16	Value=0: tariff 1; Value=1: tariff 2; Value=2: tariff 3; Value=3: tariff 4; Value=4: tariff 5; Value=5: tariff 6; Value=6: disabled	YO
305142	1415h	1	Time Slot 3 (Period 2): start	UINT16	Format: hhmm (24h format)	YO
305143	1416h	1	Time Slot 3 (Period 2): stop	UINT16	Format: hhmm (24h format)	YO
305144	1417h		Linked tariff: Time Slot 3 - Period 2	UINT16	Value=0: tariff 1; Value=1: tariff 2; Value=2: tariff 3; Value=3: tariff 4; Value=4: tariff 5; Value=5: tariff 6; Value=6: disabled	YO
305145	1418h	1	Time Slot 4 (Period 1): start	UINT16	Format: hhmm (24h format)	YO
305146	1419h	1	Time Slot 4 (Period 1): stop	UINT16	Format: hhmm (24h format)	YO
305147	141Ah		Linked tariff: Time Slot 4 - Period 1	UINT16	Value=0: tariff 1; Value=1: tariff 2; Value=2: tariff 3; Value=3: tariff 4; Value=4: tariff 5; Value=5: tariff 6; Value=6: disabled	YO
305148	141Bh	1	Time Slot 4 (Period 2): start	UINT16	Format: hhmm (24h format)	YO
305149	141Ch	1	Time Slot 4 (Period 2): stop	UINT16	Format: hhmm (24h format)	YO
305150	141Dh		Linked tariff: Time Slot 4 - Period 2	UINT16	Value=0: tariff 1; Value=1: tariff 2; Value=2: tariff 3; Value=3: tariff 4; Value=4: tariff 5; Value=5: tariff 6; Value=6: disabled	YO
305151	141Eh	1	Time Slot 5 (Period 1): start	UINT16	Format: hhmm (24h format)	YO
305152	141Fh	1	Time Slot 5 (Period 1): stop	UINT16	Format: hhmm (24h format)	YO
305153	1420h		Linked tariff: Time Slot - Period 1	UINT16	Value=0: tariff 1; Value=1: tariff 2; Value=2: tariff 3; Value=3: tariff 4; Value=4: tariff 5; Value=5: tariff 6; Value=6: disabled	YO
305154	1421h	1	Time Slot 5 (Period 2): start	UINT16	Format: hhmm (24h format)	YO
305155	1422h	1	Time Slot 5 (Period 2): stop	UINT16	Format: hhmm (24h format)	YO
305156	1423h		Linked tariff: Time Slot 5 - Period 2	UINT16	Value=0: tariff 1; Value=1: tariff 2; Value=2: tariff 3; Value=3: tariff 4; Value=4: tariff 5; Value=5: tariff 6; Value=6: disabled	YO
305157	1424h	1	Time Slot 6 (Period 1): start	UINT16	Format: hhmm (24h format)	YO
305158	1425h	1	Time Slot 6 (Period 1): stop	UINT16	Format: hhmm (24h format)	YO
305159	1426h		Linked tariff: Time Slot - Period 1	UINT16	Value=0: tariff 1; Value=1: tariff 2; Value=2: tariff 3; Value=3: tariff 4; Value=4: tariff 5; Value=5: tariff 6; Value=6: disabled	YO
305160	1427h	1	Time Slot 6 (Period 2): start	UINT16	Format: hhmm (24h format)	YO
305161	1428h	1	Time Slot 6 (Period 2): stop	UINT16	Format: hhmm (24h format)	YO
305162	1429h		Linked tariff: Time Slot 6 - Period 2	UINT16	Value=0: tariff 1; Value=1: tariff 2; Value=2: tariff 3; Value=3: tariff 4; Value=4: tariff 5; Value=5: tariff 6; Value=6: disabled	YO
305163	142Ah	1	Linked tariff: Holiday	UINT16	Value=0: tariff 1 Value=1: tariff 2 Value=2: tariff 3 Value=3: tariff 4 Value=4: tariff 5 Value=5: tariff 6 Value=6: disabled	YO
305164	142Bh	1	Holiday1: start	UINT16	Format: mddd	YO
305165	142Ch	1	Holiday1: stop	UINT16	Value < 101: disabled	YO
305166	142Dh	1	Holiday2: start	UINT16		YO
305167	142Eh	1	Holiday2: stop	UINT16		YO
305168	142Fh	1	Holiday3: start	UINT16		YO
305169	1430h	1	Holiday3: stop	UINT16		YO
305170	1431h	1	Holiday4: start	UINT16		YO
305171	1432h	1	Holiday4: stop	UINT16		YO
305172	1433h	1	Holiday5: start	UINT16		YO
305173	1434h	1	Holiday5: stop	UINT16		YO
305174	1435h	1	Holiday6: start	UINT16		YO
305175	1436h	1	Holiday6: stop	UINT16		YO

305176	1437h	1	Holiday7: start	UINT16		Y0	
305177	1438h	1	Holiday7: stop	UINT16		Y0	
305178	1439h	1	Holiday8: start	UINT16		Y0	
305179	143Ah	1	Holiday8: stop	UINT16		Y0	
305180	143Bh	1	Holiday9: start	UINT16		Y0	
305181	143Ch	1	Holiday9: stop	UINT16		Y0	
305182	143Dh	1	Holiday10: start	UINT16		Y0	
305183	143Eh	1	Holiday10: stop	UINT16		Y0	
305184	143Fh	1	Default Tariff	UINT16		Value=0: tariff 1 Value=1: tariff 2 Value=2: tariff 3 Value=3: tariff 4 Value=4: tariff 5 Value=5: tariff 6 Value=6: disabled Reference tariff in case of wrong programming (**)	Y0

(*) In case of Value = 1 the module MFlxx isn't necessary

(**) In case of "Tariff from clock/input/command" Value =3 this register is the Tariff selector

2.12.8 Neutral current direct measurement + Temperature + Process signal measurements (°C/°F) (Module Ref. 16 and 17)

MODBUS: Read and write mode

Table 2.12-14

Modicom address	Physical address	Length (words)	VARIABLE ENG. UNIT	Data Format	Notes	Firmware compatibility
305633	1600h	1	Temperature engineering unit	UINT 16	0=Celsius; 1=Fahrenheit	Y0
305634	1601h	1	Temperature probe type	UINT 16	0=Pt100 (3W); 1=Pt100 (2W); 2=Pt1000 (3W); 3=Pt1000 (2W)	Y0
305635	1602h	2	Process Signal - Electrical Scale - Low	32 bit IEEE 754	-20.0 ÷ 20.0 (mA)	Y0
305637	1604h	2	Process Signal - Electrical Scale - High	32 bit IEEE 754	-20.0 ÷ 20.0 (mA)	Y0
305639	1606h	2	Process Signal - Display Scale - Low	32 bit IEEE 754	-9999M ÷ 9999M	Y0
305641	1608h	2	Process Signal - Display Scale - High	32 bit IEEE 754	-9999M ÷ 9999M	Y0
305793	16A0h	2	Current RATIO	32 bit IEEE 754	1 ÷ 9999	Y0

2.12.9 Profibus (See 2.12.1 Table: Module Ref. 20)

MODBUS: Read and write mode

Table 2.12-15

Modicom address	Physical address	Length (words)	VARIABLE ENG. UNIT	Data Format	Notes	Firmware compatibility
306145	1800h	32	Profile 0 variables configuration	Customized data structure		X21, Y17, Z0
306177	1820h	32	Profile 1 variables configuration	Customized data structure		X21, Y17, Z0
306209	1840h	32	Profile 2 variables configuration	Customized data structure		X21, Y17, Z0
306241	1860h	32	Profile 3 variables configuration	Customized data structure		X21, Y17, Z0
306273	1880h	32	Profile 4 variables configuration	Customized data structure		X21, Y17, Z0
306305	18A0h	32	Profile 5 variables configuration	Customized data structure		X21, Y17, Z0
306337	18C0h	32	Profile 6 variables configuration	Customized data structure		X21, Y17, Z0
306369	18E0h	32	Profile 7 variables configuration	Customized data structure		X21, Y17, Z0
306401	1900h	32	Profile 8 variables configuration	Customized data structure		X21, Y17, Z0
306433	1920h	32	Profile 9 variables configuration	Customized data structure		X21, Y17, Z0
306465	1940h	32	Profile 10 variables configuration	Customized data structure		X21, Y17, Z0
306497	1960h	32	Profile 11 variables configuration	Customized data structure		X21, Y17, Z0
306529	1980h	1	Profibus address	UINT16	Value min = 2 Value max = 125 Default = 126	X21, Y17, Z0
306530	1981h	1	Profile 0 endian configuration	UINT16	Big endian = 0 (Default) Little endian = 1	X21, Y17, Z0

306531	1982h	1	Profile 1 endian configuration	UINT16	Big endian = 0 (Default) Little endian = 1	X21, Y17, Z0
306532	1983h	1	Profile 2 endian configuration	UINT16	Big endian = 0 (Default) Little endian = 1	X21, Y17, Z0
306533	1984h	1	Profile 3 endian configuration	UINT16	Big endian = 0 (Default) Little endian = 1	X21, Y17, Z0
306534	1985h	1	Profile 4 endian configuration	UINT16	Big endian = 0 (Default) Little endian = 1	X21, Y17, Z0
306535	1986h	1	Profile 5 endian configuration	UINT16	Big endian = 0 (Default) Little endian = 1	X21, Y17, Z0
306536	1987h	1	Profile 6 endian configuration	UINT16	Big endian = 0 (Default) Little endian = 1	X21, Y17, Z0
306537	1988h	1	Profile 7 endian configuration	UINT16	Big endian = 0 (Default) Little endian = 1	X21, Y17, Z0
306538	1989h	1	Profile 8 endian configuration	UINT16	Big endian = 0 (Default) Little endian = 1	X21, Y17, Z0
306539	198Ah	1	Profile 9 endian configuration	UINT16	Big endian = 0 (Default) Little endian = 1	X21, Y17, Z0
306540	198Bh	1	Profile 10 endian configuration	UINT16	Big endian = 0 (Default) Little endian = 1	X21, Y17, Z0
306541	198Ch	1	Profile 11 endian configuration	UINT16	Big endian = 0 (Default) Little endian = 1	X21, Y17, Z0
306542	198Dh	1	Current Profibus profile	UINT16	Only read mode Value min = 0 Value max = 11	X21, Y17, Z0

Profibus variables configuration

Table 2.12-16

Modicom address	Physical address	Length (words)	VARIABLE ENG. UNIT	Data Format	Notes	Firmware compatibility
Block address +0	Block address +0	1	Profibus Profile Variable 0	UINT16	(*)	X21, Y17, Z0
Block address +1	Block address +1	1	Profibus Profile Variable 1	UINT16	(*)	X21, Y17, Z0
Block address +2	Block address +2	1	Profibus Profile Variable 2	UINT16	(*)	X21, Y17, Z0
Block address +3	Block address +3	1	Profibus Profile Variable 3	UINT16	(*)	X21, Y17, Z0
Block address +4	Block address +4	1	Profibus Profile Variable 4	UINT16	(*)	X21, Y17, Z0
Block address +5	Block address +5	1	Profibus Profile Variable 5	UINT16	(*)	X21, Y17, Z0
Block address +6	Block address +6	1	Profibus Profile Variable 6	UINT16	(*)	X21, Y17, Z0
Block address +7	Block address +7	1	Profibus Profile Variable 7	UINT16	(*)	X21, Y17, Z0
Block address +8	Block address +8	1	Profibus Profile Variable 8	UINT16	(*)	X21, Y17, Z0
Block address +9	Block address +9	1	Profibus Profile Variable 9	UINT16	(*)	X21, Y17, Z0
Block address +10	Block address +10	1	Profibus Profile Variable 10	UINT16	(*)	X21, Y17, Z0
Block address +11	Block address +11	1	Profibus Profile Variable 11	UINT16	(*)	X21, Y17, Z0
Block address +12	Block address +12	1	Profibus Profile Variable 12	UINT16	(*)	X21, Y17, Z0
Block address +13	Block address +13	1	Profibus Profile Variable 13	UINT16	(*)	X21, Y17, Z0
Block address +14	Block address +14	1	Profibus Profile Variable 14	UINT16	(*)	X21, Y17, Z0
Block address +15	Block address +15	1	Profibus Profile Variable 15	UINT16	(*)	X21, Y17, Z0
Block address +16	Block address +16	1	Profibus Profile Variable 16	UINT16	(*)	X21, Y17, Z0
Block address +17	Block address +17	1	Profibus Profile Variable 17	UINT16	(*)	X21, Y17, Z0
Block address +18	Block address +18	1	Profibus Profile Variable 18	UINT16	(*)	X21, Y17, Z0
Block address +19	Block address +19	1	Profibus Profile Variable 19	UINT16	(*)	X21, Y17, Z0
Block address +20	Block address +20	1	Profibus Profile Variable 20	UINT16	(*)	X21, Y17, Z0
Block address +21	Block address +21	1	Profibus Profile Variable 21	UINT16	(*)	X21, Y17, Z0
Block address +22	Block address +22	1	Profibus Profile Variable 22	UINT16	(*)	X21, Y17, Z0
Block address +23	Block address +23	1	Profibus Profile Variable 23	UINT16	(*)	X21, Y17, Z0

Block address +24	Block address +24	1	Profibus Profile Variable 24	UINT16	(*)	X21, Y17, Z0
Block address +25	Block address +25	1	Profibus Profile Variable 25	UINT16	(*)	X21, Y17, Z0
Block address +26	Block address +26	1	Profibus Profile Variable 26	UINT16	(*)	X21, Y17, Z0
Block address +27	Block address +27	1	Profibus Profile Variable 27	UINT16	(*)	X21, Y17, Z0
Block address +28	Block address +28	1	Profibus Profile Variable 28	UINT16	(*)	X21, Y17, Z0
Block address +29	Block address +29	1	Profibus Profile Variable 29	UINT16	(*)	X21, Y17, Z0
Block address +30	Block address +30	1	Profibus Profile Variable 30	UINT16	(*)	X21, Y17, Z0
Block address +31	Block address +31	1	Profibus Profile Variable 31	UINT16	(*)	X21, Y17, Z0

(*) Refer to the Variable List (paragraphs 2.5-2.10): the variable is identified by its own Modbus address and will be transmitted in Float 32 format.
To transmit the variables in INT format, add 8000h to its own Modbus address.

To transmit energy meters or counters values, the addresses of both 32-bit high part and 32-bit low part must be set in 2 consecutive Profile variables.

In case of energy meters and counters values, the 32-bit low part transmitted by Profibus is relevant to units, the 32-bit high part transmitted by Profibus is relevant to G (giga) multiplier.

It is possible also to transmit status words (e.g. 4000h, virtual alarm status). In Profibus the format is the same.

If the address is set as FFFFh, the relevant input value is 0.

2.12.10 Commands table

MODBUS: write only mode

Table 2.12-17

Modicom address	Physical address	Length (words)	VARIABLE ENG. UNIT	Data Format	Notes	Firmware compatibility
312369	3050h	1	Get clock values	UINT 16	Value=1: command executed Value≠1: no effect	X0, Y0
312370	3051h	1	Set clock values	UINT 16	Value=1: data and time set	X0, Y0
					Value=2: time set only (Use this command for the sync without generating any events)	X2, Y0
312371	3052h	1	(*) External serial communication configuration updating	UINT 16	Value=1: command executed Value≠1: no effect	X0, Y0, Z0
312372	3053h	1	(*) Optical serial communication configuration updating	UINT 16	Value=1: command executed Value≠1: no effect	Y0, Z0
312373	3054h	1	Set/reset MOR2	UINT 16	Value=1: module enabled Value=0: module disabled	X0, Y0, Z0
312374	3055h	1	Set/reset MO02	UINT 16	Value=1: module enabled Value=0: module disabled	X0, Y0, Z0
312375	3056h	1	Set/reset MC232485	UINT 16	Value=1: module enabled Value=0: module disabled	X0, Y0, Z0
312376	3057h	1	Stop DB DMD and unlock dmd area (this command also resets all the DB DMD indices)	UINT 16	Value=1: command executed Value≠1: no effect	Y0
312377	3058h	1	Restart DB DMD and lock dmd area	UINT 16	Value=1: command executed Value≠1: no effect	Y0
312379	3060h	1	Reset Bacnet Description to default value	UINT 16	Value=1: command executed (English Language) Value=2: command executed (German Language) Value≠1,2: no effect	X15, Y12, Z0
312417	3080h	1	Set clock values with hour and minute (without generating any events)	UINT 16		X2, Y0
312545	3100h	1	Reset all remote outputs (MOR2 / MO02)	UINT 16	Value=1: command executed Value≠1: no effect	X0, Y0, Z0
312546	3101h	1	Remote output command on port 1 (MOR2 / MO02)	UINT 16	Value=0: reset port Value≠0: set port	X0, Y0, Z0
312547	3102h	1	Remote output command on port 2 (MOR2 / MO02)	UINT 16	Value=0: reset port Value≠0: set port	X0, Y0, Z0
312548	3103h	1	Set all remote outputs (MOR2 / MO02)	UINT 16	Value=1: command executed Value≠1: no effect	X0, Y0, Z0
312549	3104h	1	Reset all remote outputs (MFI606 / MFI6R4)	UINT 16	Value=1: command executed Value≠1: no effect	Y0
312550	3105h	1	Remote output command on port 3 (MFI606 / MFI6R4)	UINT 16	Value=0: reset port Value=1: set port Other values: no effect	Y0
312551	3106h	1	Remote output command on port 4 (MFI606 / MFI6R4)	UINT 16	Value=0: reset port Value=1: set port Other values: no effect	Y0
312552	3107h	1	Remote output command on port 5 (MFI606 / MFI6R4)	UINT 16	Value=0: reset port Value=1: set port Other values: no effect	Y0
312553	3108h	1	Remote output command on port 6 (MFI606 / MFI6R4)	UINT 16	Value=0: reset port Value=1: set port Other values: no effect	Y0
312554	3109h	1	Remote output command on port 7 (MFI606 / MFI6R4)	UINT 16	Value=0: reset port Value=1: set port Other values: no effect	Y0
312555	310Ah	1	Remote output command on port 8 (MFI606 / MFI6R4)	UINT 16	Value=0: reset port Value=1: set port Other values: no effect	Y0
312556	310Bh	1	Set all remote outputs (MFI606 / MFI6R4)	UINT 16	Value=1: command executed Value≠1: no effect	Y0
312625	3150h	1	Reset all latch status	UINT 16	Value=1: command executed Value≠1: no effect	Y0
312801	3200h	1	Reset V L1-N	UINT 16	Bit0 = Max Value (X0, Y0) Bit1 = DMD (X0, Y0) Bit2 = DMD Max Value (Y0) Bit3 = Min Value (Y0) Where the bit is set to "1", there is reset	
312802	3201h	1	Reset V L2-N	UINT 16		
312803	3202h	1	Reset V L3-N	UINT 16		
312804	3203h	1	Reset V L-N Σ	UINT 16		
312805	3204h	1	Reset V L1-L2	UINT 16		
312806	3205h	1	Reset V L2-L3	UINT 16		
312807	3206h	1	Reset V L3-L1	UINT 16		
312808	3207h	1	Reset V L-L Σ	UINT 16		
312809	3208h	1	Reset A L1	UINT 16		
312810	3209h	1	Reset A L2	UINT 16		
312811	320Ah	1	Reset A L3	UINT 16		
312812	320Bh	1	Reset A N	UINT 16		

312813	320Ch	1	Reset W L1	UINT 16	
312814	320Dh	1	Reset W L2	UINT 16	
312815	320Eh	1	Reset W L3	UINT 16	
312816	320Fh	1	Reset W Σ	UINT 16	
312817	3210h	1	Reset VA L1	UINT 16	
312818	3211h	1	Reset VA L2	UINT 16	
312819	3212h	1	Reset VA L3	UINT 16	
312820	3213h	1	Reset VA Σ	UINT 16	
312821	3214h	1	Reset VAR L1	UINT 16	
312822	3215h	1	Reset VAR L2	UINT 16	
312823	3216h	1	Reset VAR L3	UINT 16	
312824	3217h	1	Reset VAR Σ	UINT 16	
312825	3218h	1	Reset PF L1	UINT 16	
312826	3219h	1	Reset PF L2	UINT 16	
312827	321Ah	1	Reset PF L3	UINT 16	
312828	321Bh	1	Reset PF Σ	UINT 16	
312829	321Ch	1	Reset Hz	UINT 16	
312830	321Dh	1	Reset Asymmetry L-N %	UINT 16	
312831	321Eh	1	Reset Asymmetry L-L %	UINT 16	
			RESERVED		
312833	3220h	1	Reset A Σ	UINT 16	Bit0 = Max Value (X16) Bit1 = DMD (X16) Where the bit is set to "1", there is reset
312833	3220h	1	Reset K Factor L1	UINT 16	Bit0 = Max Value (Y0)
312834	3221h	1	Reset K Factor L2	UINT 16	Bit1 = DMD (Y0)
312835	3222h	1	Reset K Factor L3	UINT 16	Bit2 = DMD Max Value (Y0)
312836	3223h	1	Reset Temperature	UINT 16	Bit3 = Min Value (Y0)
312837	3224h	1	Reset analogue input	UINT 16	Where the bit is set to "1", there is reset
312838	3225h	1	Reset A Σ	UINT 16	
312839	3226h	1	THD tot VL1-N	UINT 16	Bit1 = Max Value (X0, Y0)
312840	3227h	1	THD tot VL2-N	UINT 16	Bit2 = DMD (X0, Y0)
312841	3228h	1	THD tot VL3-N	UINT 16	Bit3 = DMD Max Value (Y0)
312842	3229h	1	THD tot VL12	UINT 16	Bit4 = Min Value (Y0)
312843	322Ah	1	THD tot VL23	UINT 16	Where the bit is set to "1" there is reset
312844	322Bh	1	THD tot VL31	UINT 16	
312845	322Ch	1	THD tot AL1	UINT 16	
312846	322Dh	1	THD tot AL2	UINT 16	
312847	322Eh	1	THD tot AL3	UINT 16	
312848	322Fh	1	THD even VL1-N	UINT 16	Bit1 = Max Value (Y0)
312849	3230h	1	THD even VL2-N	UINT 16	Bit2 = DMD (Y0)
312850	3231h	1	THD even VL3-N	UINT 16	Bit3 = DMD Max Value (Y0)
312851	3232h	1	THD even VL12	UINT 16	Bit4 = Min Value (Y0)
312852	3233h	1	THD even VL23	UINT 16	Where the bit is set to "1" there is reset
312853	3234h	1	THD even VL31	UINT 16	
312854	3235h	1	THD even AL1	UINT 16	
312855	3236h	1	THD even AL2	UINT 16	
312856	3237h	1	THD even AL3	UINT 16	
312857	3238h	1	THD odd VL1-N	UINT 16	
312858	3239h	1	THD odd VL2-N	UINT 16	
312859	323Ah	1	THD odd VL3-N	UINT 16	
312860	323Bh	1	THD odd VL12	UINT 16	
312861	323Ch	1	THD odd VL23	UINT 16	
312862	323Dh	1	THD odd VL31	UINT 16	
312863	323Eh	1	THD odd AL1	UINT 16	
312864	323Fh	1	THD odd AL2	UINT 16	
312865	3240h	1	THD odd AL3	UINT 16	
312866	3241h	1	TDD AL1	UINT 16	
312867	3242h	1	TDD AL2	UINT 16	
312878	3243h	1	TDD AL3	UINT 16	
312813	320Ch	1	Reset W L1	UINT 16	Bit0 = Max Value (Z0)
312814	320Dh	1	Reset W L2	UINT 16	Bit1 = DMD (Z0)
312815	320Eh	1	Reset W L3	UINT 16	Where the bit is set to "1", there is reset
312816	320Fh	1	Reset W Σ	UINT 16	
312817	3210h	1	Reset VA L1	UINT 16	
312818	3211h	1	Reset VA L2	UINT 16	
312819	3212h	1	Reset VA L3	UINT 16	
312820	3213h	1	Reset VA Σ	UINT 16	
312821	3214h	1	Reset VAR L1	UINT 16	
312822	3215h	1	Reset VAR L2	UINT 16	
312823	3216h	1	Reset VAR L3	UINT 16	
312824	3217h	1	Reset VAR Σ	UINT 16	
313569	3500h	1	Reset Total KWh+	UINT 16	Value=1: command executed X0, Y0, Z0
313570	3501h	1	Reset Total Kvarh+	UINT 16	Value=1: command executed X0, Y0, Z0

313571	3502h	1	Reset Total KWh-	UINT 16	Value=1: command executed	X0, Y0, Z0
313572	3503h	1	Reset Total Kvarh-	UINT 16	Value=1: command executed	X0, Y0, Z0
313573	3504h	1	Reset Partial KWh+	UINT 16	Value=1: command executed	X0, Y0, Z0
313574	3505h	1	Reset Partial Kvarh+	UINT 16	Value=1: command executed	X0, Y0, Z0
313575	3506h	1	Reset Partial KWh-	UINT 16	Value=1: command executed	X0, Y0, Z0
313576	3507h	1	Reset Partial Kvarh-	UINT 16	Value=1: command executed	X0, Y0, Z0
313577	3508h	1	Reset Run Hours	UINT 16	Value=1: command executed	X0, Y0, Z0
313578	3509h	1	Reset Tariff 1 KWh+	UINT 16	Value=1: command executed	Y0
313579	350Ah	1	Reset Tariff 1 Kvarh+	UINT 16	Value=1: command executed	Y0
313580	350Bh	1	Reset Tariff 1 KWh-	UINT 16	Value=1: command executed	Y0
313581	350Ch	1	Reset Tariff 1 Kvarh-	UINT 16	Value=1: command executed	Y0
313582	350Dh	1	Reset Tariff 2 KWh+	UINT 16	Value=1: command executed	Y0
313583	350Eh	1	Reset Tariff 2 Kvarh+	UINT 16	Value=1: command executed	Y0
313584	350Fh	1	Reset Tariff 2 KWh-	UINT 16	Value=1: command executed	Y0
313585	3510h	1	Reset Tariff 2 Kvarh-	UINT 16	Value=1: command executed	Y0
313586	3511h	1	Reset Tariff 3 KWh+	UINT 16	Value=1: command executed	Y0
313587	3512h	1	Reset Tariff 3 Kvarh+	UINT 16	Value=1: command executed	Y0
313588	3513h	1	Reset Tariff 3 KWh-	UINT 16	Value=1: command executed	Y0
313589	3514h	1	Reset Tariff 3 Kvarh-	UINT 16	Value=1: command executed	Y0
313590	3515h	1	Reset Tariff 4 KWh+	UINT 16	Value=1: command executed	Y0
313591	3516h	1	Reset Tariff 4 Kvarh+	UINT 16	Value=1: command executed	Y0
313592	3517h	1	Reset Tariff 4 KWh-	UINT 16	Value=1: command executed	Y0
313593	3518h	1	Reset Tariff 4 Kvarh-	UINT 16	Value=1: command executed	Y0
313594	3519h	1	Reset Tariff 5 KWh+	UINT 16	Value=1: command executed	Y0
313595	351Ah	1	Reset Tariff 5 Kvarh+	UINT 16	Value=1: command executed	Y0
313596	351Bh	1	Reset Tariff 5 KWh-	UINT 16	Value=1: command executed	Y0
313597	351Ch	1	Reset Tariff 5 Kvarh-	UINT 16	Value=1: command executed	Y0
313598	351Dh	1	Reset Tariff 6 KWh+	UINT 16	Value=1: command executed	Y0
313599	351Eh	1	Reset Tariff 6 Kvarh+	UINT 16	Value=1: command executed	Y0
313600	351Fh	1	Reset Tariff 6 KWh-	UINT 16	Value=1: command executed	Y0
313601	3520h	1	Reset Tariff 6 Kvarh-	UINT 16	Value=1: command executed	Y0
313602	3521h	1	Reset C1	UINT 16	Value=1: command executed	Y0
313603	3522h	1	Reset C2	UINT 16	Value=1: command executed	Y0
313604	3523h	1	Reset C3	UINT 16	Value=1: command executed	Y0
313825	3600h	1	Reset DB - DMD	UINT 16	Value=1: command executed Value≠1: no effect	Y0
313826	3601h	1	Reset DB – Events	UINT 16	Value=1: command executed Value≠1: no effect	Y0
313827	3602h	1	Reset DB - Load profiling	UINT 16	Value=1: command executed Value≠1: no effect	Y0

(*) Wait at least 6 seconds before communicating with the new parameter.

2.12.11 Status

MODBUS: Read mode

Table 2.12-18

Modicom address	Physical address	Length (words)	VARIABLE ENG. UNIT	Data Format	Notes	Firmware compatibility
316385	4000h	1	Virtual alarm	UINT 16	Bit value: 0 = OFF Bit value: 1 = ON Bit position (LSB concept): 0: Alarm1 1: Alarm2	X0, Y0, Z0
					2: Alarm3 3: Alarm4	X0, Y0
					4: Alarm5 5: Alarm6 6: Alarm7 7: Alarm8 8: Alarm9 9: Alarm10 10: Alarm11 11: Alarm12 12 : Alarm13 13 : Alarm14 14 : Alarm15 15 : Alarm16	Y0

316386	4001h	1	Output (port)	UINT 16	<p>Bit value: 0 = OFF Bit value: 1 = ON (Note: only if the port is not linked to the counter)</p> <p>Bit position (LSB concept): 0: Port1 1: Port2</p>	X0, Y0, Z0
316386	4001h	1	Output (port)	UINT 16	<p>Bit value: 0 = OFF Bit value 1 = 0 (Note: only if port is not linked to the counter)</p> <p>Bit position (LSB concept): 2: Port3 3: Port4 4: Port5 5: Port6 6: Port7 7: Port8</p> <p>Bit value: 0 = alarm or remote config port Bit value : 1 = pulse config port</p> <p>Bit position (MSB concept): 8: Port1 9: Port2 10: Port3 11: Port4 12: Port5 13: Port6 14: Port7 15: Port8</p>	Y0
316387	4002h	1	HW modules configuration	UINT 16	<p>Bit value: 0 = module not present Bit value: 1 = module present</p> <p>Bit position: 0: HW_MOR2 1: HW_MOO2 2: HW_MC485232 3: HW_MCETH 4: HW_MCBACIP 5: HW_MOA2 6: HW_MOV2</p>	X0
316387	4002h	1	HW modules configuration	UINT 16	<p>Bit value: 0 = module not present Bit value: 1 = module present</p> <p>Bit position: 0: HW_MOR2 1: HW_MOO2 2: HW_MC485232 3: HW_MCETH 4: HW_MCBACIP 5: HW_MOA2 6: HW_MOV2 7: HW_MFI6R4 8: HW_MFI6O6 9: HW_MATP 10: HW_MATPN 11: HW_MEMORY 12: HW_MOA2 (hw position 2) 13: HW_MOV2 (hw position 2)</p>	Y0
316387	4002h	1	HW modules configuration	UINT 16	<p>Bit value: 0 = module not present Bit value: 1 = module present</p> <p>Bit position: 0: HW_MOR2 1: HW_MOO2 2: HW_MC232485 3: HW_MCETH 4: HW_MCBACIP 5: HW_MOA2 6: HW_MOV2 7: HW_MCBACMS 8: HW_MCETHIP</p>	X14

316387	4002h	1	HW modules configuration	UINT 16	Bit value: 0 = module not present Bit value: 1 = module present Bit position: 0: HW_MOR2 1: HW_MOO2 2: HW_MC485232 3: HW_MCETH 4: HW_MCBACIP 5: HW_MOA2 6: HW_MOV2 7: HW_MFI6R4 8: HW_MFI6O6 9: HW_MATP 10: HW_MATPN 11: HW_MEMORY 12: HW_MOA2 (hw position 2) 13: HW_MOV2 (hw position 2) 14: HW_MCBACMS 15: HW_MCETHIP	Y11
316387	4002h	1	HW modules configuration	UINT 16	Bit value: 0 = module not present Bit value: 1 = module present Bit position: 0: HW_MOR2 1: HW_MOO2 2: HW_MC232485 3: HW_MCETH 4: HW_MCBACIP 5: HW_MOA2 6: HW_MOV2 7: HW_MCBACMS 8: HW_MCETHIP 9: HW_MCPB	X21
316387	4002h	1	HW modules configuration	UINT 16	Bit value: 0 = module not present Bit value: 1 = module present Bit position: 0: HW_MOR2 1: HW_MOO2 2: HW_MC485232 3: HW_MCETH 4: HW_MCBACIP 5: HW_MCBACMS 6: HW_MCPB	Z0
316388	4003h	1	Input (port)	UINT 16	Bit value: 0 (ON) = closed Bit value: 1 (OFF) = open Bit position (LSB concept): 0: Port1 1: Port2 2: Port3 3: Port4 4: Port5 5: Port6	Y0
316389	4004h	1	Output setup (port)	UINT 16	Bit value: 0 = NO Bit value: 1 = NC Bit position (LSB concept): 2: Port3 3: Port4 4: Port5 5: Port6 6: Port7 7: Port8	Y0
316390	4005h	1	Input previous state	UINT 16	Bit value: 0 (ON) = closed Bit value: 1 (OFF) = open Bit position (LSB concept): 0: Port1 1: Port2 2: Port3 3: Port4 4: Port5 5: Port6	Y0
316391	4006h	1	HW modules configuration 2	UINT 16	Bit value: 0 = module not present Bit value: 1 = module present Bit position: 0: HW_MCPB	Y17

2.12.12 Code Variables List

Protocol Code X0	Protocol Code Y0	Protocol Code Z0	VARIABLE ENG. UNIT	Notes	Firmware compatibility
0	0	0	V L1-N		X0, Y0, Z0
1	1	1	V L2-N		X0, Y0, Z0
2	2	2	V L3-N		X0, Y0, Z0
3	3	3	V L-N Σ		X0, Y0, Z0
4	4	4	V L1-L2		X0, Y0, Z0
5	5	5	V L2-L3		X0, Y0, Z0
6	6	6	V L3-L1		X0, Y0, Z0
7	7	7	V L-L Σ		X0, Y0, Z0
8	8	8	A L1		X0, Y0, Z0
9	9	9	A L2		X0, Y0, Z0
10	10	10	A L3		X0, Y0, Z0
11	11	11	A N		X0, Y0, Z0
12	12	12	W L1		X0, Y0, Z0
13	13	13	W L2		X0, Y0, Z0
14	14	14	W L3		X0, Y0, Z0
15	15	15	W Σ		X0, Y0, Z0
16	16	16	VA L1		X0, Y0, Z0
17	17	17	VA L2		X0, Y0, Z0
18	18	18	VA L3		X0, Y0, Z0
19	19	19	VA Σ		X0, Y0, Z0
20	20	20	VAR L1		X0, Y0, Z0
21	21	21	VAR L2		X0, Y0, Z0
22	22	22	VAR L3		X0, Y0, Z0
23	23	23	VAR Σ		X0, Y0, Z0
24	24	24	PF L1		X0, Y0, Z0
25	25	25	PF L2		X0, Y0, Z0
26	26	26	PF L3		X0, Y0, Z0
27	27	27	PF Σ		X0, Y0, Z0
28	28	28	Hz		X0, Y0, Z0
29	29		Asymmetry L-N %		X0, Y0
30	30		Asymmetry L-L %		X0, Y0
31	31	29	Phase sequence		X0, Y0, Z0
	32		K-Factor L1		Y0
	33		K-Factor L2		Y0
	34		K-Factor L3		Y0
	35		Temperature		Y0
	36		Analogue Input		Y0
32	37	30	THD tot VL1-N		X0, Y0, Z0
33	38	31	THD tot VL2-N		X0, Y0, Z0
34	39	32	THD tot VL3-N		X0, Y0, Z0
35	40	33	THD tot VL12		X0, Y0, Z0
36	41	34	THD tot VL23		X0, Y0, Z0
37	42	35	THD tot VL31		X0, Y0, Z0
38	43	36	THD tot AL1		X0, Y0, Z0
39	44	37	THD tot AL2		X0, Y0, Z0
40	45	38	THD tot AL3		X0, Y0, Z0
41	67	39	A Σ		X16, Y13, Z0
	46		THD odd VL1-N		Y0
	47		THD odd VL2-N		Y0
	48		THD odd VL3-N		Y0
	49		THD odd VL12		Y0
	50		THD odd VL23		Y0
	51		THD odd VL31		Y0
	52		THD odd AL1		Y0
	53		THD odd AL2		Y0
	54		THD odd AL3		Y0
	55		THD even VL1-N		Y0
	56		THD even VL2-N		Y0
	57		THD even VL3-N		Y0
	58		THD even VL12		Y0
	59		THD even VL23		Y0
	60		THD even VL31		Y0
	61		THD even AL1		Y0
	62		THD even AL2		Y0
	63		THD even AL3		Y0
	64		TDD tot AL1		Y0
	65		TDD tot AL2		Y0
	66		TDD tot AL3		Y0
		40	W L1 dmd		Z0
		41	W L2 dmd		Z0

		42	W L3 dmd		Z0
		43	W Σ dmd		Z0
		44	VA L1 dmd		Z0
		45	VA L2 dmd		Z0
		46	VA L3 dmd		Z0
		47	VA Σ dmd		Z0
		48	VAR L1 dmd		Z0
		49	VAR L2 dmd		Z0
		50	VAR L3 dmd		Z0
		51	VAR Σ dmd		Z0

3 Database System

The integers are represented in UINT16 (16 bit) or UINT32(32 bit) or UINT64 (64 bit) format without sign (the byte order inside the single word is MSB->LSB while the word order is LSW->MSW).

The float IEEE754 are represented in UINT32(32 bit) format without sign (the byte order inside the single word is MSB->LSB while the word order is LSW->MSW).

3.1 Table of “Data Event” file

The “Data event” (also known as “DE”) is a file with 10000 records (from index 0000 to 9999). The record is organised in 11 words as illustrated in table 2.6.2. The “data event” file is readable with Modbus function code 14h using file number 0.

The “data event” has a FIFO management system and uses two reference record numbers to identify the first record available (RefA) and the last record stored (RefB). If RefB > RefA, the records valid are from RefA+1 to RefB, if RefA > RefB, the records valid are from RefA+1 to 9999 and from 0 to RefB.

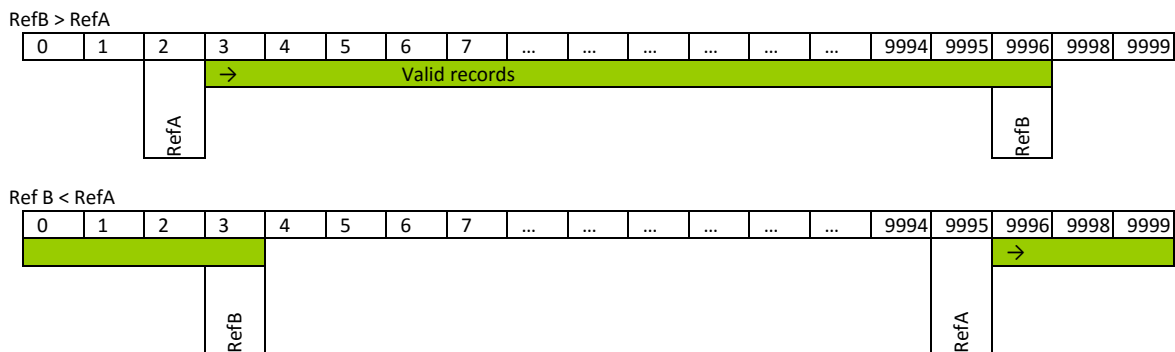

To read the “data event” file it is necessary to execute the following actions:

- 1) Read the reference of the first record available (RefA) and the reference of the last record stored (RefB) using Modbus function code 04h or 03h.
- 2) Read the valid records using Modbus function code 14h and sub-function code 06h. The identification file number for the data base is 0.
- 3) When all records are read, write the reference number RefA with the value of RefB (Modbus function code 06h). This action executes an equivalent reset function.

Table 3.1-1 - “Data event” file: reference record numbers

Modicon address	HEX Physical address	Description	Data Format	Notes	Firmware compatibility
308193	2000h	“Data event”: First record available (RefA)	INT16	0÷9999 (it is possible the “write” and “read” mode access)	Y0
308194	2001h	“Data event”: Last record stored (RefB)	INT16	0÷9999 (it is possible only the “read” mode access)	Y0

Table 3.1-2 - “Data event” file: record layout

HEX Physical address	Description	Data Format	Notes	Firmware compatibility
Base+0h	Record index	INT16	0÷9999	Y0
Base+1h	Date: Year and Month	INT16	LSB=Month (1÷12) MSB=Year (08÷50)	Y0
Base+2h	Date: Day and Hour	INT16	LSB=Hour (0÷23) MSB=Day (01÷31)	Y0
Base+3h	Date: Minute and Second	INT16	LSB=Second (0÷59) MSB=Minute (0÷59)	Y0
From Base+004h to Base+00Ah	Record fields	7 word	See “Data event record field”, table 2.7-3	Y0

Table 3.1-3 – “Data event” file: record field layout vs. event type

Event Type	Description	Address	Length (words)	Data Format	Notes	Firmware compatibility
0=Alarm	Type of event	Base+4h	1	UINT16	0=Alarm	Y0
	Type of sub event	Base+5h	1	UINT16	MSB: Value=0: UP control Value=1: DOWN control Value=2: IN control Value=3: OUT control	Y0



	Type of variable	Base+6h	1	UINT16	LSB Alarm type: Value=0: activated Value=1: deactivated MSB: number of virtual alarms LSB: Refer to the Code Variable List (2.12.11)	Y0
	Alarm link code	Base+7h	1	UINT16	MSB: ones of physical output (0: none, 1-8 port) LSB: physical output logic: Value=0: OR Value=1: AND	Y0
	Variable value	Base+8h	2	32 bit IEEE 754	Depending on the type of variable If NAN this event is generated by Reset	Y0
1=Digital input	Type of event	Base+4h	1	UINT16	1=Digital input	Y0
	Number of input channels	Base+5h	1	UINT16	0: Port1 1: Port2 2: Port3 3: Port4 4: Port5 5: Port6	Y0
	New status	Base+6h	1	UINT16	1 (OFF) = open 0 (ON) = closed	Y0
2=Digital output	Type of event	Base+4h	1	UINT16	2 = digital output	Y0
	Number of output channels	Base+5h	1	UINT16	0: Port1 1: Port2 2: Port3 3: Port4 4: Port5 5: Port6 6: Port7 7: Port8	Y0
	New status	Base+6h		UINT16	0 (OFF) = deactivated 1 (ON) = activated	Y0
	Type of output	Base+7h	1	UINT16	0=Remote 1=Alarm	Y0
3=Reset	Type of event	Base+4h	1	UINT16	3=Reset	Y0
	Type of reset	Base+5h	1	UINT16	See "Reset type" on Table 2.7-5	Y0
	Sub type	Base+6h	1	UINT16	Variable code (only if valid)	Y0
4=General	Type of event	Base+4h	1	UINT16	4 = General	Y0
	Type of error	Base+5h	1	UINT16	See "General type" on Table 2.7-5	Y0
	New status	Base+6h	1	UINT16	0=activated 1=deactivated	Y0
5=Max/Min	Type of event	Base+4h	1	UINT16	5=Max/Min	Y0
	Type of sub event	Base+5h	1	UINT16	LSB Value: 0=max Value: 1=DMD max Value: 2=min	Y0
	Type of variable	Base+6h	1	UINT16	LSB: See Table "Variable code"	Y0
	Variable value	Base+7h	2	32 bit IEEE 754	Depending on the type of variable If NAN this event is generated by Reset	Y0

Table 3.1-4 - "Data event" file: General type

Word value	Link
0	
1	
2	
3	
4	
5	
6	
7	
8	
9	
10	Local access to the programming mode
11	Power off
12	Power on
13	
14	Parameters were stored
15	

Table 3.1-5 - "Data event" file: Reset type

Word value	Link
0	Reset Energy
1	Max Value
2	DMD
3	Min Value
4	DMD Max Value
5	DB Reset – DMD
6	DB Reset – Event
7	DB Reset - Load Profiling
8	
9	
10	
11	
12	
13	
14	
15	

3.2 Table of "Data Load Profiling" file

The "Data Load profiling" (also known as "DLP") is composed by **21** files (every file has 10000 records from index 0000 to 9999). The record is organized in different words depending on the number of variables that are joined. This is illustrated in the table 2.5.2. The DLP file is readable with Modbus function code 14h using the specific file number from **1** to **21**. The DLP has a circular management system and uses four reference record numbers to identify the first available file (FiA), the last available file (FiB), the first available record into the file (RefA) and the last stored record (RefB).

If $FiB > FiA$, the valid files are from FiA to FiB , if $FiA > FiB$, the valid records are from FiA to **21** and from **1** to FiB .

If $RefB > RefA$, the valid records are from $RefA+1$ to $RefB$, if $RefA > RefB$, the valid records are from $RefA+1$ to 9999 and from 1 to $RefB$.

NOTE: the maximum index for 21TH file is 1600

FiB > FiA

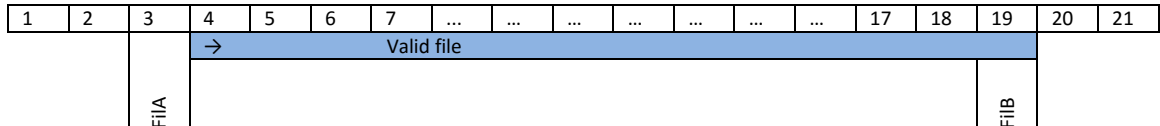

FiA > FiB

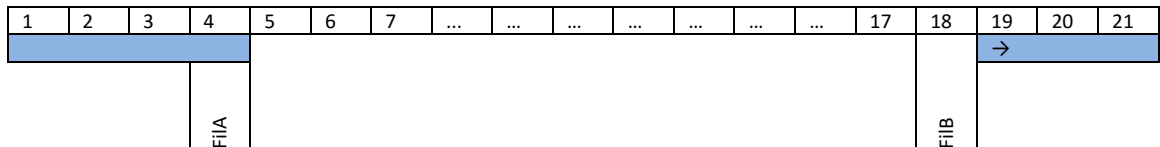

RefB > RefA



Ref B < RefA

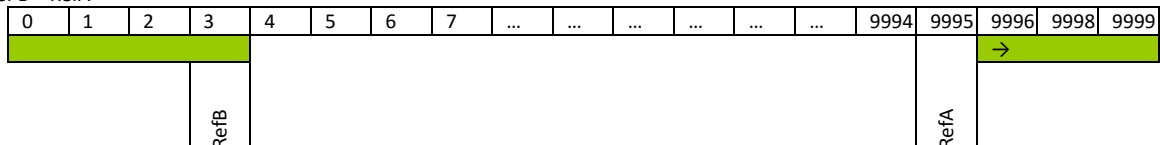

To read the DLP file it is necessary to execute the following actions:



- 1) Read the reference of the first available file (FiLA) and the reference of the last stored file (FiLB) using the Modbus function code 04h or 03h.
- 2) Read the reference of the first available record (RefA) and the reference of the last stored record (RefB) using the Modbus function code 04h or 03h.
- 3) Read the valid records using the Modbus function code 14h and the sub-function code 06h. The identification files number for the data base are from FiLA to FiLB.
- 4) When all the records are read, write the reference number RefA with the value of RefB (Modbus function code 06h). This action executes an equivalent reset function.

Table 3.2-1 - "Data Load profiling" file: reference record numbers

Modicon address	HEX Physical address	Description	Data Format	Notes	Firmware compatibility
308195	2002h	First number of file (FiLA)	INT16	0÷n (it is possible the "write" and "read" mode access)	Y0
308196	2003h	Last number of file (FiLB)	INT16	0 ÷n (it is possible only the "read" mode access)	Y0
308197	2004h	"Data Load profiling": First available record (RefA)	INT16	0÷9999 (it is possible the "write" and "read" mode access)	Y0
308198	2005h	"Data Load profiling": Last stored record (RefB)	INT16	0÷9999 (it is possible only the "read" mode access)	Y0

Table 3.2-2 - "Data Load profiling" file: record organisation

HEX Physical address	Description	Data Format	Notes	Firmware compatibility
Base+0h	Record index	INT16	0÷9999	Y0
Base+1h	Date: Year and Month	INT16	LSB=Month (1÷12) MSB=Year (08÷50)	Y0
Base+2h	Date: Day and Hour	INT16	LSb=Hour (0÷23) MSB=Day (01÷31)	Y0
Base+3h	Date: Minute and Second	INT16	LSB=Second (0÷59) MSB=Minute (0÷59)	Y0
Base+4h	Record fields	INT16	0 = Wtot 1 = vartot	Y0
Base+5h	Value	32 bit IEEE 754	Value	Y0

3.3 Table of "Data Base" file

The "Data base" (also known as "DB") is composed by **n** files (every file has 10000 records from index 0000 to 9999). The record is organized in different words depending on the number of variables that are joined. This is illustrated in table 2.5.2. The DB file is readable with the Modbus function code 14h using the specific file number from **22** to **n**. The DB has a circular management system and uses four reference record numbers to identify the first available file (FiLA), the last available file (FiLB), the first available record into the file (RefA) and the last stored record (RefB).

If $FiLB > FiLA$, the valid files are from FiLA to FiLB, if $FiLA > FiLB$, the valid records are from FiLA to **n** and from **22** to FiLB.

If $RefB > RefA$, the valid records are from RefA+1 to RefB, if $RefA > RefB$, the valid records are from RefA+1 to 9999 and from 1 to RefB.

FiLB > FiLA

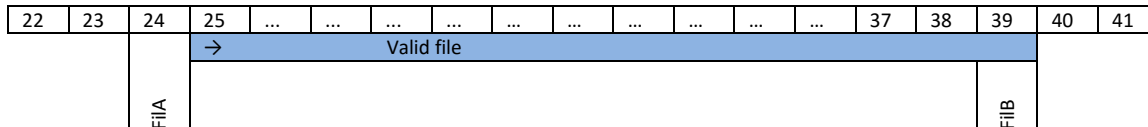

FiLB > FiLA

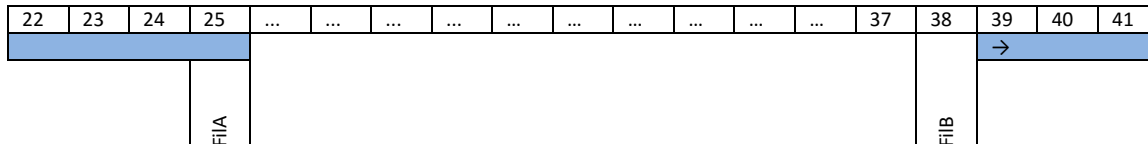

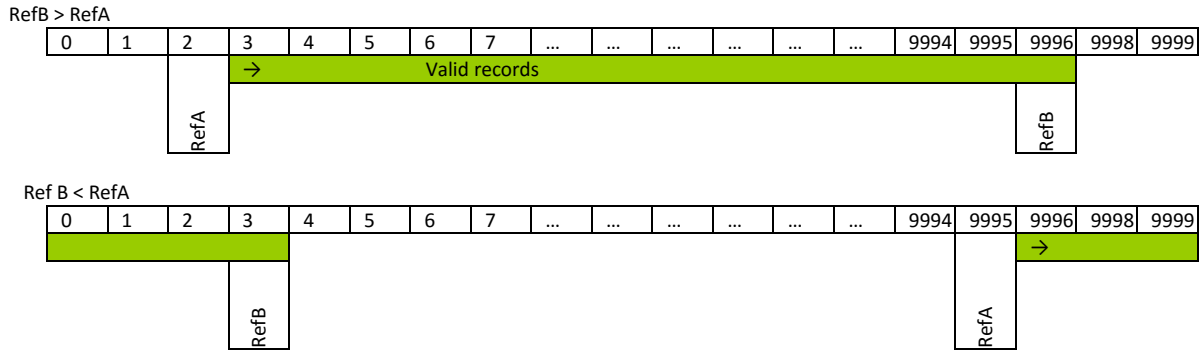

To read the DB file it is necessary to execute the following actions:

- 5) Read the reference of the first available file (FilA) and the reference of the last stored file (FilB) using the Modbus function code 04h or 03h.
- 6) Read the reference of the first available record (RefA) and the reference of the last stored record (RefB) using the Modbus function code 04h or 03h.
- 7) Read the valid records using the Modbus function code 14h and sub-function code 06h. The identification files number for the data base are from FilA to FilB.
- 8) When all the records are read, write the reference number RefA with the value of RefB (Modbus function code 06h). This action executes an equivalent reset function.

Table 3.3-1 - "Data base" file: reference record numbers

Modicon address	HEX Physical address	Description	Data Format	Notes	Firmware compatibility
308199	2006h	First number of the file (FilA)	INT16	0 ÷ n (it is possible the "write" and "read" mode access)	Y0
308200	2007h	Last number of the file (FilB)	INT16	0 ÷ n (it is possible only the "read" mode access)	Y0
308201	2008h	"Data Base": First available record (RefA)	INT16	0 ÷ 9999 (it is possible the "write" and "read" mode access)	Y0
308202	2009h	"Data Base": Last stored record (RefB)	INT16	0 ÷ 9999 (it is possible only the "read" mode access)	Y0
308203	200Ah	Max valid number of the file	INT16		Y0
308204	200Bh	Max valid index of the last file	INT16		Y0

Table 3.3-2 - "Data base" file: record structure

HEX Physical address	Length (words)	Description	Data Format	Notes	Firmware compatibility
Base+0h	1	Record index	INT16	0÷9999	Y0
Base+1h	1	Date: Year and Month	INT16	LSB=Month (1÷12) MSB=Year (08÷50)	Y0
Base+2h	1	Date: Day and Hour	INT16	LSB=Hour (0÷23) MSB=Day (01÷31)	Y0
Base+3h	1	Date: Minute and Second	INT16	LSB=Second (0÷59) MSB=Minute (0÷59)	Y0
Base+4h	1	Number of variables / Status and type	INT16	MSB: status (enabled) Value=0: NO Value=1: YES Bit 0: DMD Bit 1: MAX Bit 2: MIN LSB: number of variables	Y0
	2 - 6	DMD / Max / Min - Variable 1	32 bit IEEE 754		Y0
	2 - 6	DMD / Max / Min - Variable 2	32 bit IEEE 754		Y0
	2 - 6	DMD / Max / Min - Variable 3	32 bit IEEE 754		Y0
	2 - 6	DMD / Max / Min - Variable 4	32 bit IEEE 754		Y0
	2 - 6	DMD / Max / Min - Variable 5	32 bit IEEE 754		Y0
	2 - 6	DMD / Max / Min - Variable 6	32 bit IEEE 754		Y0
	2 - 6	DMD / Max / Min - Variable 7	32 bit IEEE 754		Y0
	2 - 6	DMD / Max / Min - Variable 8	32 bit IEEE 754		Y0
	2 - 6	DMD / Max / Min - Variable 9	32 bit IEEE 754		Y0
	2 - 6	DMD / Max / Min - Variable 10	32 bit IEEE 754		Y0
	2 - 6	DMD / Max / Min - Variable 12	32 bit IEEE 754		Y0
	2 - 6	DMD / Max / Min - Variable 12	32 bit IEEE 754		Y0
	2 - 6	DMD / Max / Min - Variable 13	32 bit IEEE 754		Y0
	2 - 6	DMD / Max / Min - Variable 14	32 bit IEEE 754		Y0
	2 - 6	DMD / Max / Min - Variable 15	32 bit IEEE 754		Y0

	2 - 6	DMD / Max / Min - Variable 16	32 bit IEEE 754		Y0
	2 - 6	DMD / Max / Min - Variable 17	32 bit IEEE 754		Y0
	2 - 6	DMD / Max / Min - Variable 18	32 bit IEEE 754		Y0
	2 - 6	DMD / Max / Min - Variable 19	32 bit IEEE 754		Y0
	2 - 6	DMD / Max / Min - Variable 20	32 bit IEEE 754		Y0

4 Revisions

4.0 Modifications from Version 2.8

- Modify 2.2 Firmware version: add register 0006h for PROFIBUS module
- Modify 1.2.4 Function 10h behavior only for “Profibus Profile Variable x”.
- Removed the section “2.5.1 Additional info for instantaneous variables” .
- Introduced the management of “M C PB” module at address 4002h for WM30 models.
- Added the address 4006h for managing “M C PB” module for WM40 models.
- Updated section 2.12.1 “Modules map” with “M C PB” module.
- Added table 2.12.9 to manage PROFIBUS configuration addresses.
- Table 2.12-13 add Value=3 at physical address 1400h as tariff selection by modbus command: selected tariff is “Default Tariff” at 143Fh.
- Updated table 2.8-1 introducing the reading of DMD THD tot values in WM30 models

4.1 Modifications from Version 2.9

- Added management of WM20 models
- Corrected errors in table 2.12.10 (the addresses of reset of THD variables was wrong, “odd” and “even” were exchanged and introduced reset of A_{Σ} in models WM30 and WM40)