

Proximity Inductive Sensors Extended Range, Nickel-Plated Brass Housing Types ICB, M18

CARLO GAVAZZI



- Sensing distance: 8 to 14 mm
- Flush or non-flush types
- Short or long body versions
- Rated operational voltage (U_b): 10 - 36 VDC
- Output: DC 200 mA, NPN or PNP
- Normally open or Normally closed
- LED indication for output ON
- Protection: reverse polarity, short circuit, transients
- Cable or M12 plug versions
- According to IEC 60947-5-2
- Laser engraved on front cap, permanently legible
- CSA certified for Hazardous Locations



Product Description

A family of inductive proximity switches in industrial standard nickel-plated brass housings. They are able to handle applications where high sensing range is requested.

Output is open collector NPN or PNP transistors.

Ordering Key **ICB18S30F08NOM1**

Type	_____
Housing style	_____
Housing material	_____
Housing size	_____
Housing length	_____
Thread length	_____
Detection principle	_____
Sensing distance	_____
Output type	_____
Output configuration	_____
Connection	_____

Type Selection

Connection	Body style	Rated operating distance S_n	Ordering no. NPN, Normally open	Ordering no. PNP, Normally open	Ordering no. NPN, Normally closed	Ordering no. PNP, Normally closed
Cable	Short	8 mm ¹⁾	ICB18S30F08NO	ICB18S30F08PO	ICB18S30F08NC	ICB18S30F08PC
Cable	Short	14 mm ²⁾	ICB18S30N14NO	ICB18S30N14PO	ICB18S30N14NC	ICB18S30N14PC
Plug	Short	8 mm ¹⁾	ICB18S30F08NOM1	ICB18S30F08POM1	ICB18S30F08NCM1	ICB18S30F08PCM1
Plug	Short	14 mm ²⁾	ICB18S30N14NOM1	ICB18S30N14POM1	ICB18S30N14NCM1	ICB18S30N14PCM1
Cable	Long	8 mm ¹⁾	ICB18L50F08NO	ICB18L50F08PO	ICB18L50F08NC	ICB18L50F08PC
Cable	Long	14 mm ²⁾	ICB18L50N14NO	ICB18L50N14PO	ICB18L50N14NC	ICB18L50N14PC
Plug	Long	8 mm ¹⁾	ICB18L50F08NOM1	ICB18L50F08POM1	ICB18L50F08NCM1	ICB18L50F08PCM1
Plug	Long	14 mm ²⁾	ICB18L50N14NOM1	ICB18L50N14POM1	ICB18L50N14NCM1	ICB18L50N14PCM1

¹⁾ For flush mounting in metal

²⁾ For non-flush mounting in metal

Specifications

Rated operational voltage (U_b)	10 to 36 VDC (ripple incl.)	Indication for short circuit/ overload	LED blinking (f = 2 Hz)
Ripple	≤ 10%	Assured operating sensing distance (S_a)	$0 \leq S_a \leq 0.81 \times S_n$
Output current (I_a)	≤ 200 mA @ 50°C ≤ 150 mA @ 50-70°C	Effective operating distance (S_r)	$0.9 \times S_n \leq S_r \leq 1.1 \times S_n$
OFF-state current (I_r)	≤ 50 μA	Usable operating distance (S_u)	$0.9 \times S_r \leq S_u \leq 1.1 \times S_r$
No load supply current (I_o)	≤ 15 mA	Repeat accuracy (R)	≤ 10%
Voltage drop (U_d)	Max. 2.5 VDC @ 200 mA	Differential travel (H) (Hysteresis)	1 to 20% of sensing dist.
Protection	Reverse polarity, short-circuit, transients	Ambient temperature	Operating: -25° to +70°C (-13° to +158°F) Storage: -30° to +80°C (-22° to +176°F)
Voltage transient	1 kV/0.5 J	Shock and vibration	IEC 60947-5-2/7.4
Power ON delay (t_v)	≤ 20 ms	Housing material	Body: Nickel-plated brass Front: Grey thermoplastic polyester
Operating frequency (f)	≤ 1500 Hz		
Indication for output ON	Activated LED, yellow		
NO version	Target present		
NC version	Target not present		

Specifications (cont.)

Connection	
Cable	Ø4.1 x 2 m, 3 x 0.25 mm ² , grey PVC, oil proof
Plug	M12 x 1
Degree of protection	IP 67
Weight (cable/nuts included)	
Cable	Max. 150 g
Plug	Max. 70 g
Dimensions	See diagrams below
Tightening torque	
Non-flush version	25 Nm
Flush version	
From 0 to 7 mm	20 Nm
> 7 mm	25 Nm
Approvals	<p>cULus (UL508)</p> <p>cCSAus As Process Control Equipment for Hazardous Locations.</p> <ul style="list-style-type: none"> - Class I, Division 2, Groups A, B, C and D. - T5 up to 150mA, T4A for a load current > 150mA and up to 200 mA, Enclosure Type 4.

Note: The terminal connector (version ...M1) was not evaluated. The suitability of the terminal connector should be determined in the end-use application.

Approvals (cont.)	<p>Ambient temperature</p> <p>Ta: -25° to +60°C</p> <p>CCC is not required for products with a maximum operating voltage of ≤ 36 V</p>
EMC protection	<p>IEC 61000-4-2 (ESD)</p> <p>IEC 61000-4-3</p> <p>IEC 61000-4-4</p> <p>IEC 61000-4-6</p> <p>IEC 61000-4-8</p>
MTTF_d	850 years @ 50°C (122°F)
	<p>According to IEC 60947-5-2</p> <p>8 KV air discharge,</p> <p>4 KV contact discharge</p> <p>3 V/m</p> <p>2 kV</p> <p>3 V</p> <p>30 A/m</p>

Dimensions (mm)

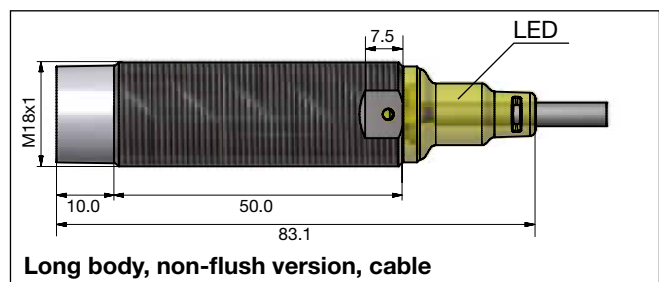
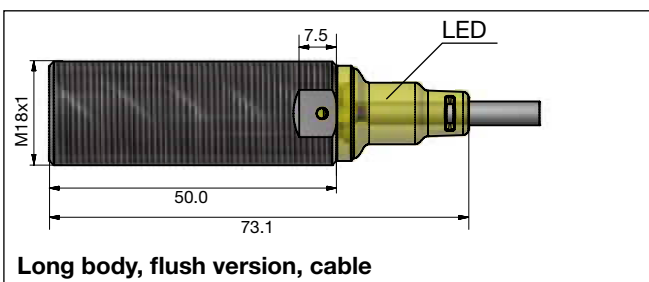
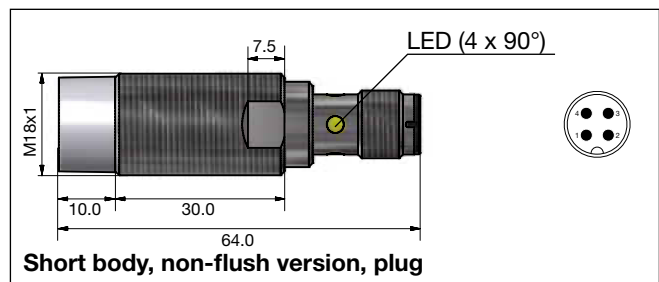
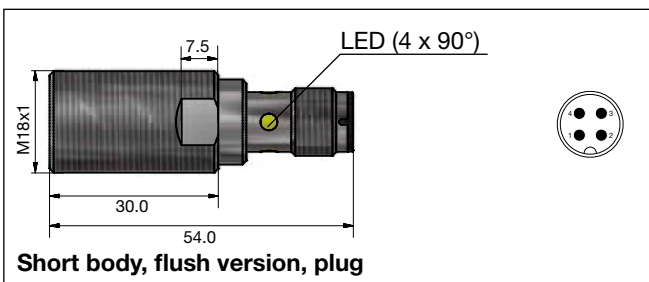
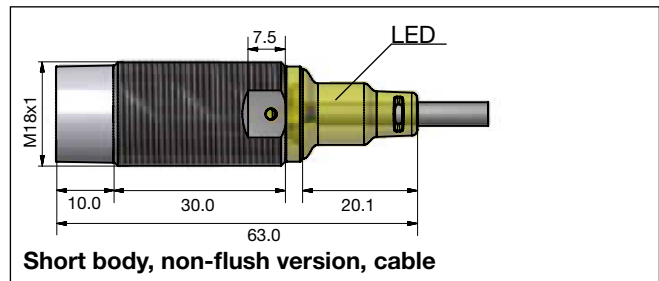
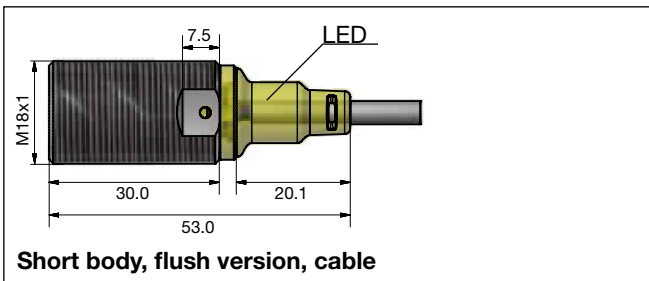

Dimensions (mm) (cont.)

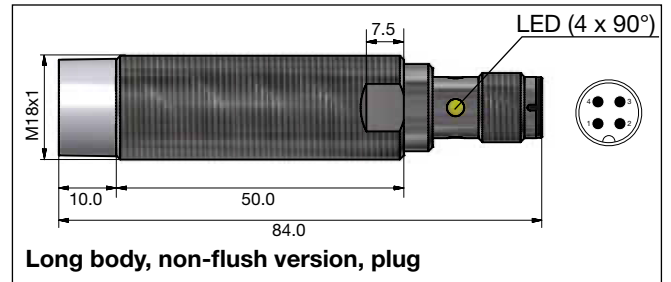
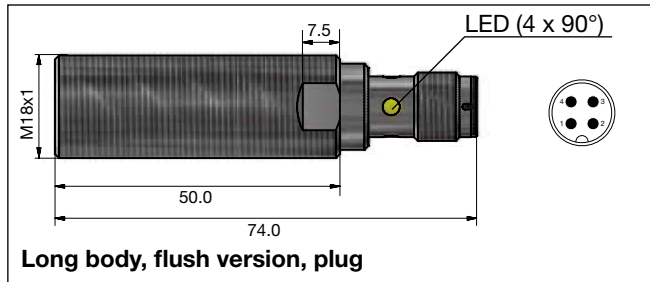

Installation

Flush sensor, when installed in damping material, must be according to Picture 1A.

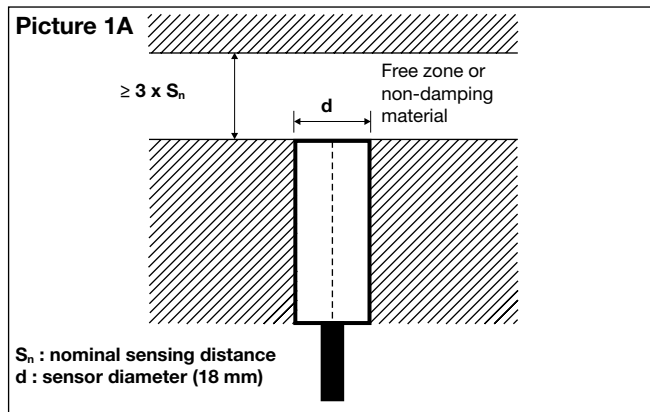

Non-flush sensor, when installed in damping material, must be according to Picture 1B.

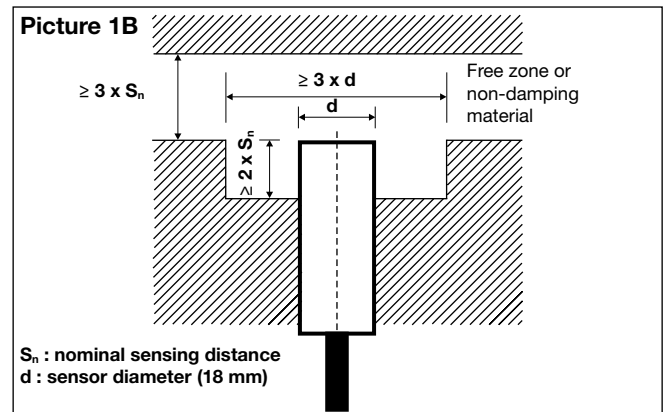

Flush sensors, when installed together in damping material, must be according to Picture 2A.

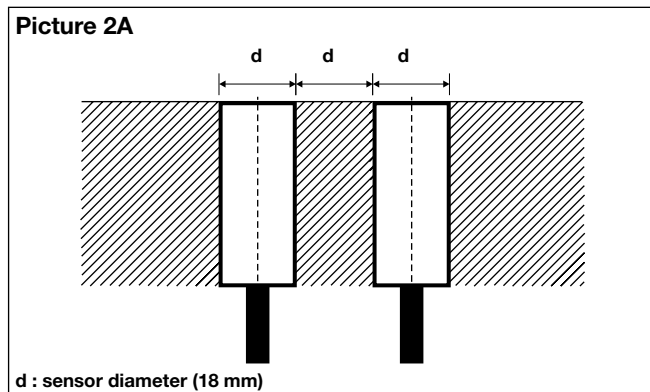

Non-flush sensors, when installed together in damping material, must be according to Picture 2B.

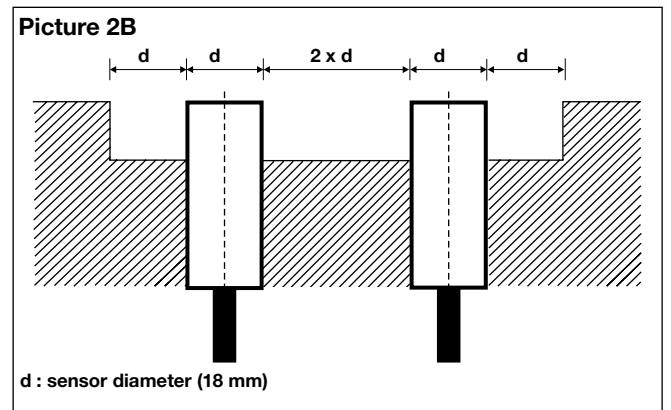

For sensors installed opposite each other, a minimum space of $6 \times S_n$ (the nominal sensing distance) must be observed (See Picture 3).

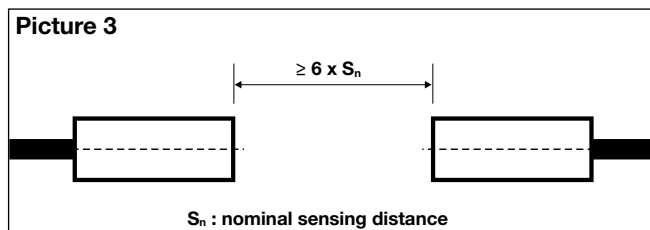



Wiring Diagram

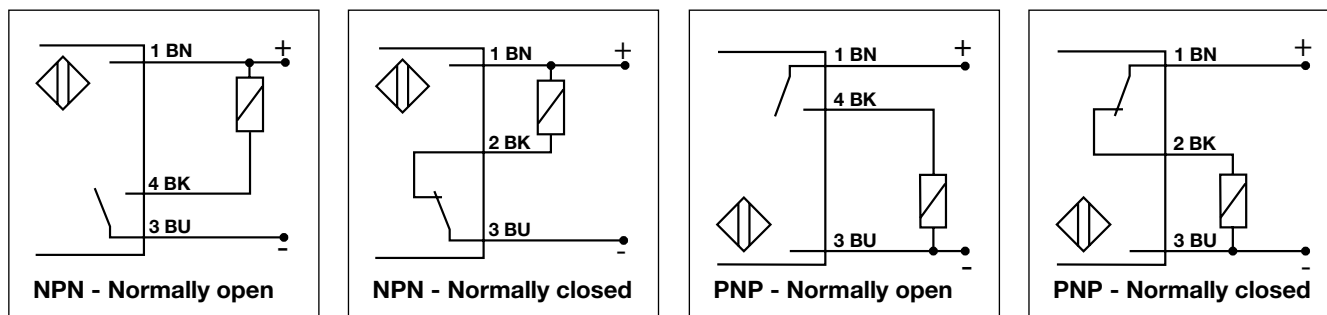

Reduction Factors

The rated operating distance is reduced by the use of metals and alloys other than Fe360.

The most important reduction factors for inductive proximity sensors are shown in Picture 4.

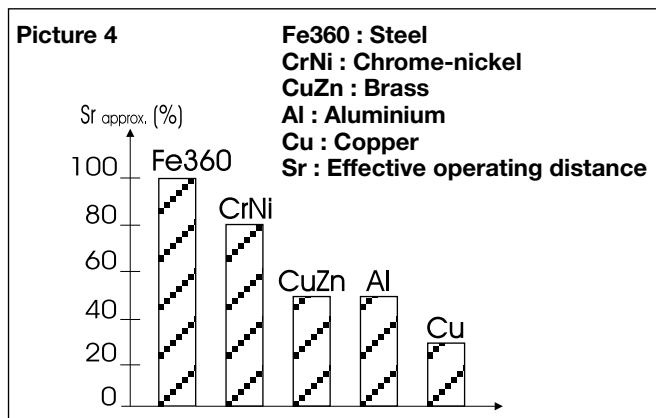

Accessories for Plug Versions

	PVC	PUR
3-wire angled connector, 2 m cable	CONB13NF-A2	CONB13NF-A2P
3-wire angled connector, 5 m cable	CONB13NF-A5	CONB13NF-A5P
3-wire angled connector, 10 m cable	CONB13NF-A10	CONB13NF-A10P
3-wire angled connector, 15 m cable	CONB13NF-A15	CONB13NF-A15P
3-wire straight connector, 2 m cable	CONB13NF-S2	CONB13NF-S2P
3-wire straight connector, 5 m cable	CONB13NF-S5	CONB13NF-S5P
3-wire straight connector, 10 m cable	CONB13NF-S10	CONB13NF-S10P
3-wire straight connector, 15 m cable	CONB13NF-S15	CONB13NF-S15P

For any additional information or different options, please refer to the "General Accessories - Connector Cables -Type CONB1..." datasheets.

Delivery Contents

- Inductive proximity switch ICB.
- 2 nuts NPB
- Packaging: plastic bag