

Tunable white DALI control

Controls

DALI control

Create an efficient environment

A variety of international regulations, including EN 15232, the European Energy Performance of Buildings Directive (EPBD 2010), ISO 50 001 and sustainability and energy certificates such as LEED (US) or Energy Star (US), have led to the creation of technical standards such as open communication protocols (BACnet and DALI) and specialized applications designed to optimize the energy efficiency of building and room automation systems. Energy savings of up to 30% can be achieved by raising awareness, making energy consumption transparent and introducing targeted energy management and control.



From profitability to sustainability

Lower energy use increases the competitive edge:

- It reduces operating costs by 13.5% in new buildings and by 8.5% in old ones*
- It increases the asset value
- Lower energy use increases the return on investment:
- ROI improvements of 9.9% in new buildings and 19.2% in old ones*
- Rent increases of 6.1% in new buildings and 1% in old ones*



Your green building

The only way to reach the targets described above, in terms of meeting regulations and profitability, is to use a building automation system: Carlo Gavazzi's solution, based on an open platform empowered by BACnet and DALI worldwide standards, helps you to maximize energy efficiency in relation to the external environmental conditions and occupancy of the building, while providing the highest levels of comfort, safety and quality.

Lighting is one of the major areas to focus on in order to reduce electricity costs, so the ability to control and monitor this is a key feature that can easily be achieved by means of the Sx2WEB controller, the programmable and intelligent unit which manages the Carlo Gavazzi system. The simplicity of the DALI bus, combined with the flexibility and scalability of the Sx2WEB platform, provides a unique and wide range of control strategies which can be adapted at any time according to the changing needs of the tenants.

*MacGraw Hill Construction, Green outlook 2016

Precise control to reduce energy bills

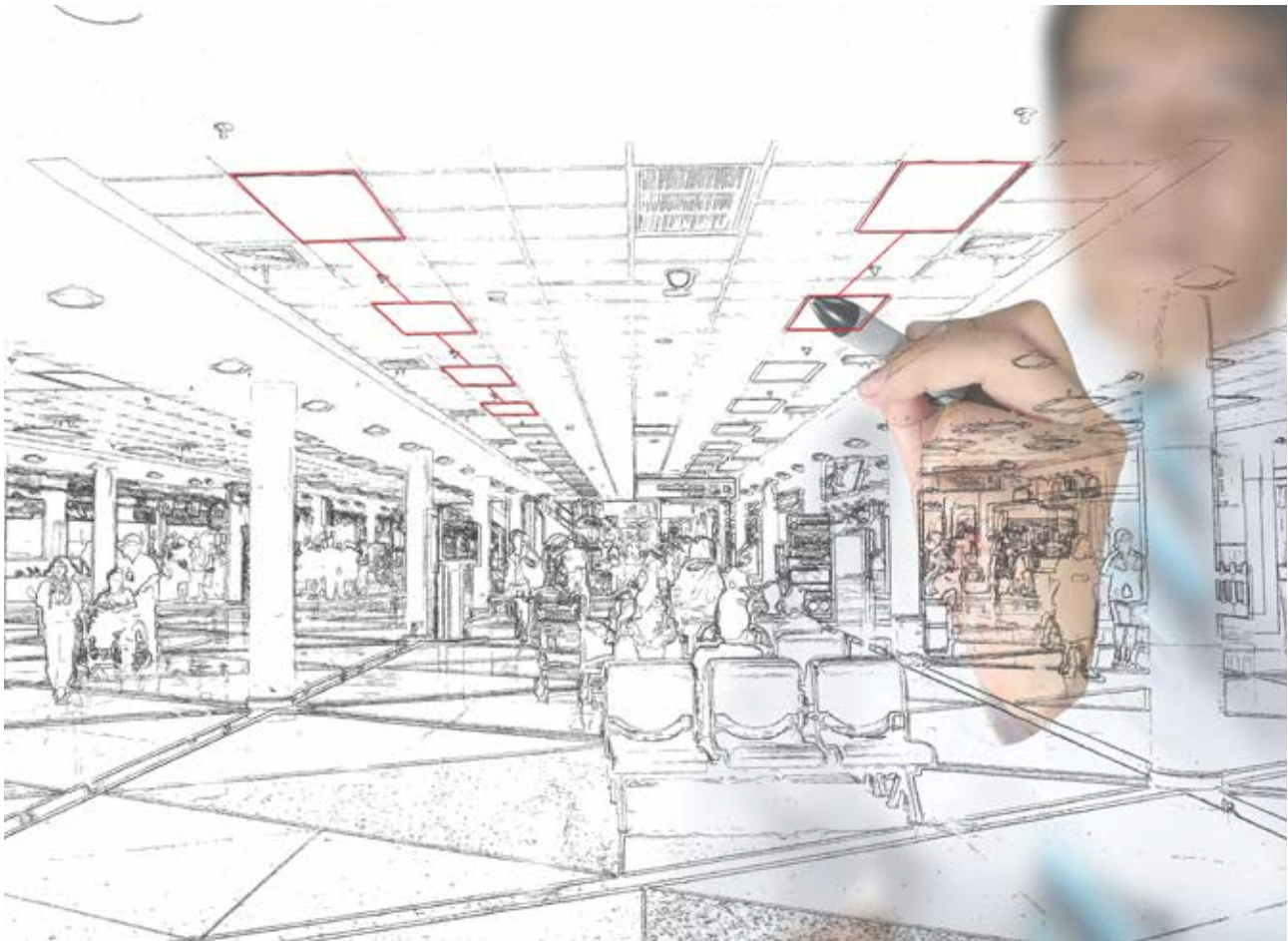

DALI bus

The DALI bus was created thanks to cooperation between the leading lighting manufacturers to create a common digital interface to control light fixtures. Today it is the world's preferred standard, which many companies have adopted. By using the DALI bus, architects, specifiers, integrators and end-users can rely on the compatibility and interchangeability of the different control gears.

The remarkable success of this standard is also due to its very easy installation (just two non-polarized wires with free topology), its low commissioning costs (no certified wires or fees are required) and its scalability and flexibility.

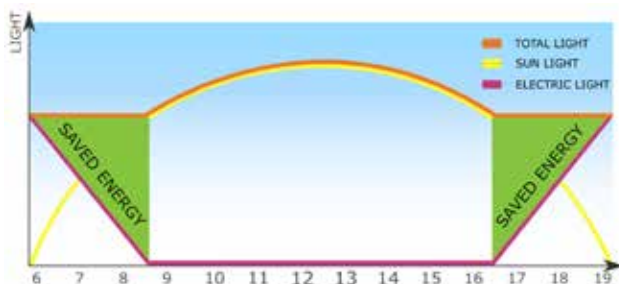

Carlo Gavazzi's clever control strategy

The DALI bus, together with the powerful Sx2WEB controller, can help you achieve a higher energy efficiency rating and meet your local green building requirements for energy savings.

The main control strategies provided by the Sx2WEB controller are:

- Daylight harvesting, which provides automatic dimming to compensate for the amount of natural light
- Automatic sunrise and sunset calculation
- Real-time clock and schedulers to switch on/off, dim or change scenario
- Light levels control according to people presence and timers
- Zone control

In addition to this, the Sx2WEB equips you with reporting files with all the data you need to check if the energy targets are met or if any further improvement can be made.

DAI control

Tunable white DALI control

Wellbeing and performance are influenced by light

Our biological clock is regulated by light and darkness:

- In the morning, as the sun comes up, light levels increase, the colour of light shifts towards cooler colour temperatures, and we wake up and become active.
- In the evening, as the sun goes down and the colour of light shifts towards warmer colour temperatures, we

unwind, relax and prepare for sleep.

Our body's hormone levels rise and fall with these light cycles, so mimicking this behaviour is becoming more and more popular in indoor lighting, to improve the quality of life and performance of people.

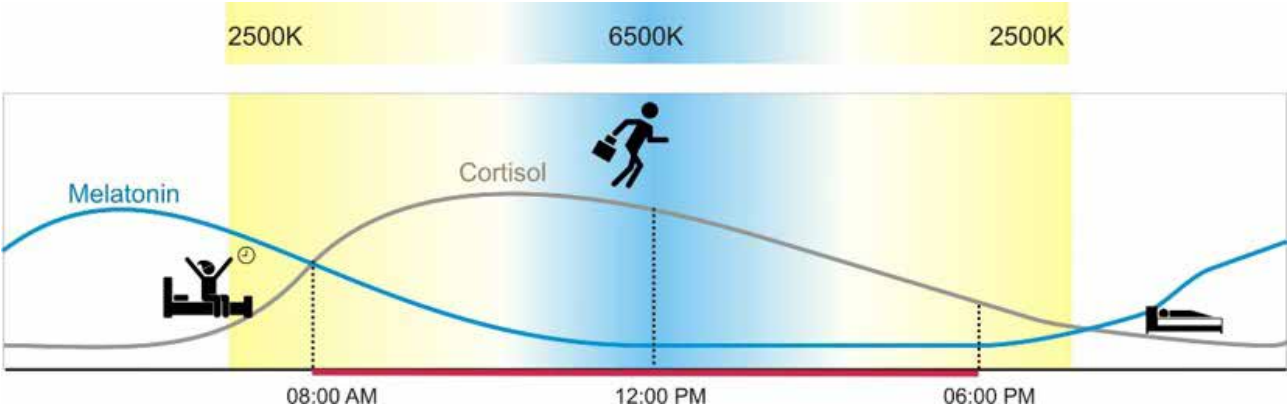

The graph above shows how our hormones change during the day according to the colour temperature: cortisol is our waking hormone, whilst melatonin controls our sleeping rhythm. Warmer temperature is more relaxing, while cooler temperature creates a motivating environment.

Tunable white: indoor light follows our circadian rhythm

Thanks to ever-improving LED technology, all the mainstream LED lighting companies are moving to offer products which can change the white of the light from warm (2500K) to cold (6000K) to follow the behaviour of natural white.

This feature is called tunable white or Kelvin colour temperature-change or CCT (Correlated Colour Temperature) and is the capability of changing the temperature (K) of the colour of the light. Thanks to Tunable White, we can now personalise lighting to support the healthy functioning of our circadian rhythms and improve mood, performance, and sense of wellbeing. Such daylight simulation is ideal, for example, for use in offices where we have little access to the beneficial properties of daylight, helping us to feel on top form every day since static lighting conditions might disrupt our biological rhythms.

Here are some examples of colour temperature:

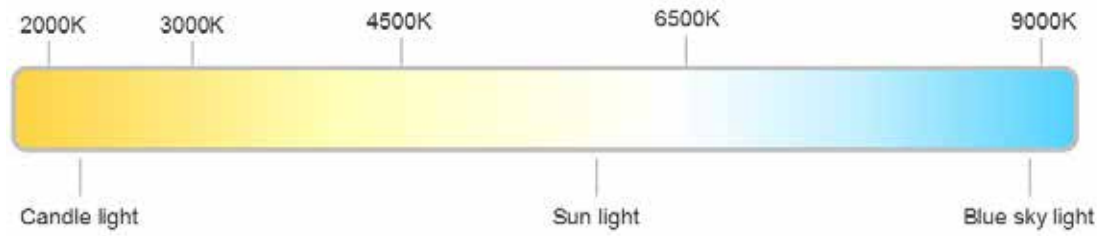

Carlo Gavazzi's solution optimizes the environment

The Sx2WEB system can be used to mimic the natural cycle of daylight, or it can be programmed to create specific scenes at certain times of the day. You can choose longer periods of more motivating light at peak times (6000K), or seamlessly move between relaxing and motivating lighting scenes (2500K) to match work and break times during the day. Systems can be pre-programmed to meet the demands

of the user or commissioned on site and updated at any time. Thanks to the integrated astronomical clock, dawn and dusk are automatically calculated according to the location, and colour temperature can be chosen to suit the need of the space.

Schedulers can be programmed to move from warm to cool light or the user can set scenarios manually by using push-buttons or by means of their smart-device.

Appealing work spaces

Nowadays people are the most important resource a company must take care of: people engagement, mood and commitment can easily be empowered taking care

of the work space in terms of CO₂ level, temperature and illumination.



Improve people performance and efficiency

As regards indoor light in a commercial environment, tunable white lighting can:

- Improve productivity
- Improve staff welfare
- Create a vibrant workplace
- Bring flexibility to multi-use spaces

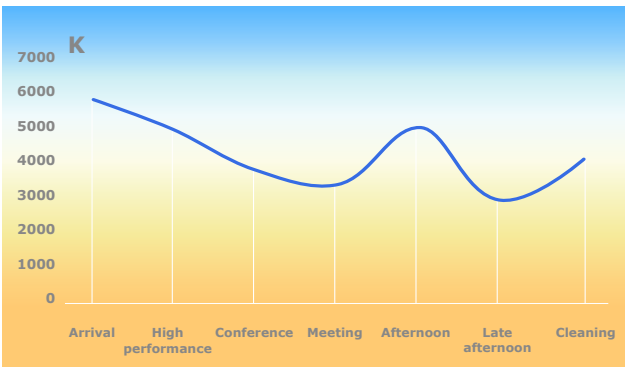

The diagram above shows some example of scenarios to provide the perfect atmosphere for each activity during a working day: cooler temperatures to support concentration and focus or to compensate for an afternoon dip in energy levels, warmer temperatures during activities which require creativity and cooperation.

Thanks to the flexible and comprehensive solution by Carlo Gavazzi, the satisfaction of employees can easily be increased by optimizing colour temperatures and brightness to provide better visual comfort.

DAI control

Tunable white DALI control

Motivating educational spaces

Thanks to the Sx2WEB system, teachers can easily activate the perfect light scene for any day's activity, maximizing the students' learning curve.



The perfect scenario to facilitate learning

In an educational environment, tunable white lighting can:

- Improve concentration
- Improve learning outcomes
- Create a dynamic environment
- Match the lighting to the learning need

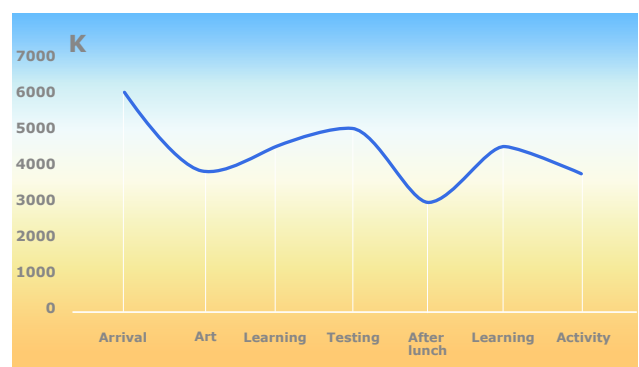

The diagram above shows some examples of scenarios to meet the perfect atmosphere for each activity during a school day: cooler temperatures to support concentration and focus during test activities, warmer temperatures during activities which require creativity and cooperation or relaxation.

Pre-set light levels and colour can be scheduled according to weekly activities, but at the same time teachers can personalise the pre-sets to achieve a more individualised lighting control of the learning environment..

High quality healthcare environment

Carlo Gavazzi's tunable white solution helps recovery and well-being in patients: whatever the clinic is, a hospital, an elderly care home or an assisted living facility, the

ability to change light intensity and colour temperature according to the needs of people improves the quality of the care.



Shorten recovery time

In a healthcare environment, tunable white lighting can:

- **Decrease recuperation time**
- **Improve patient sleep pattern**
- **Give patients control over their environment**
- **Enhance quality of care**

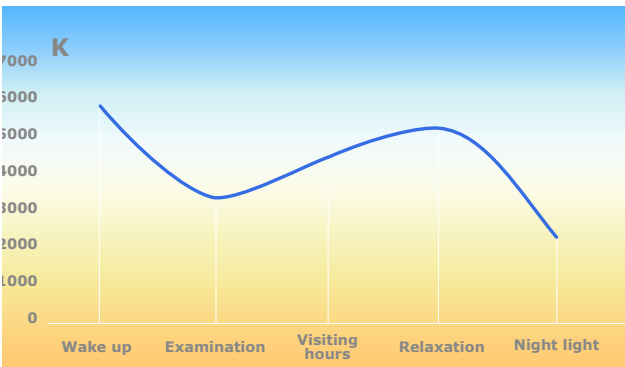

The diagram above shows some examples of scenarios to meet the perfect atmosphere for any time of day in a care environment: cooler temperatures to speed up the inner body clock in the morning, warmer temperatures for relaxation. Pre-set light levels and colour can be scheduled according to the time of the day, but at the same time patients can personalise

the pre-sets to achieve greater comfort, thus improving their satisfaction.

At the same time, a stimulating workplace engages healthcare professionals and supports their well-being and efficiency.

DALI control

Carlo Gavazzi's comprehensive system



Member of:

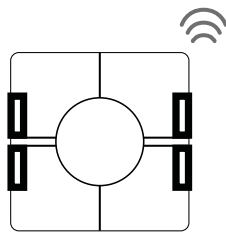

Wireless switches and sensors



Wireless actuators

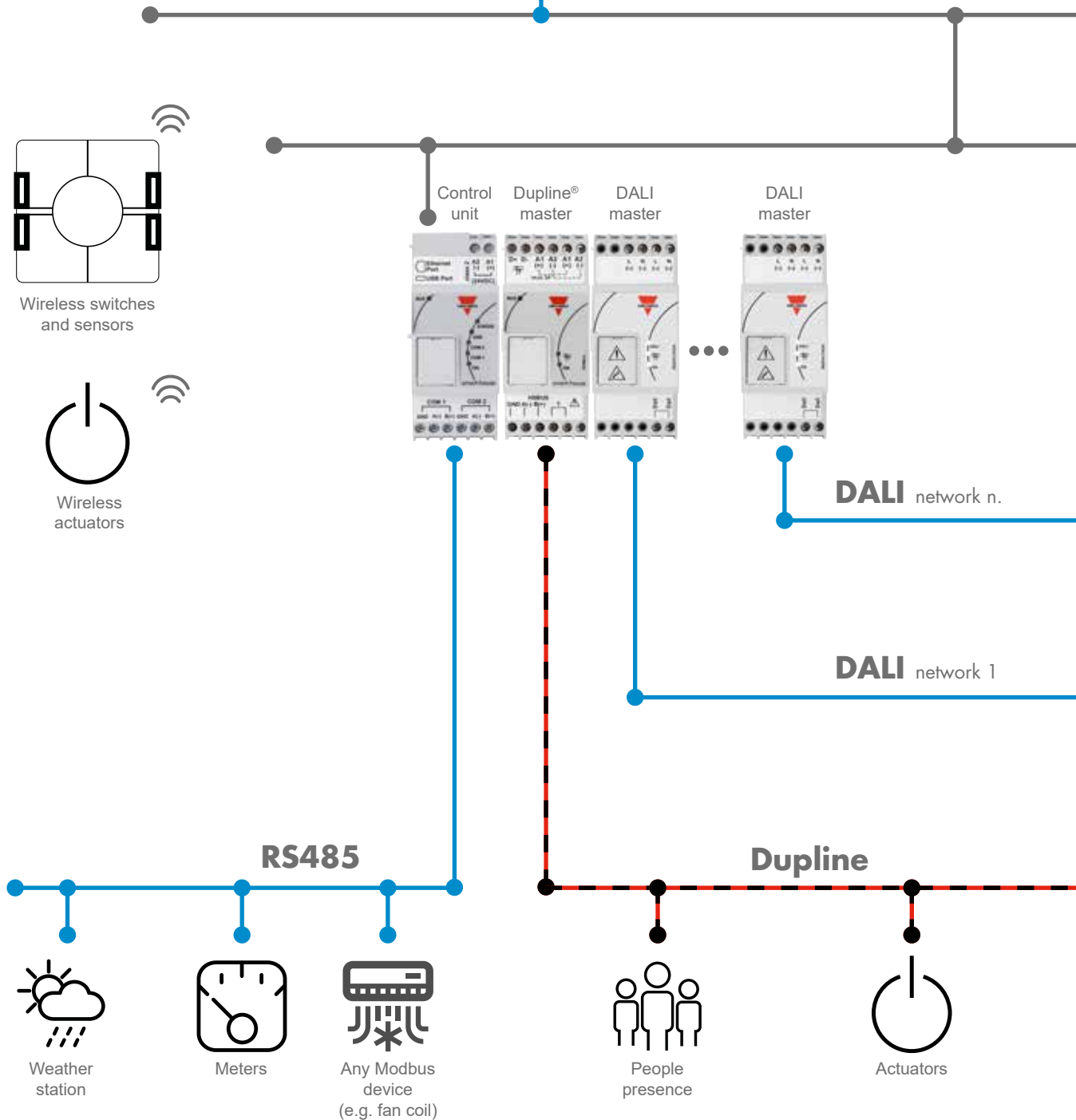



Ethernet/BACnet/Modbus TCP/IP

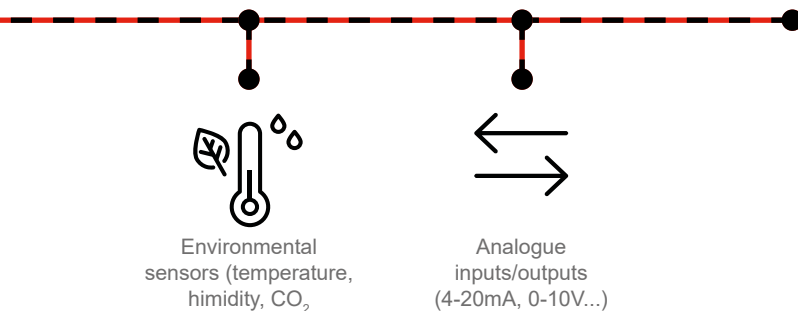
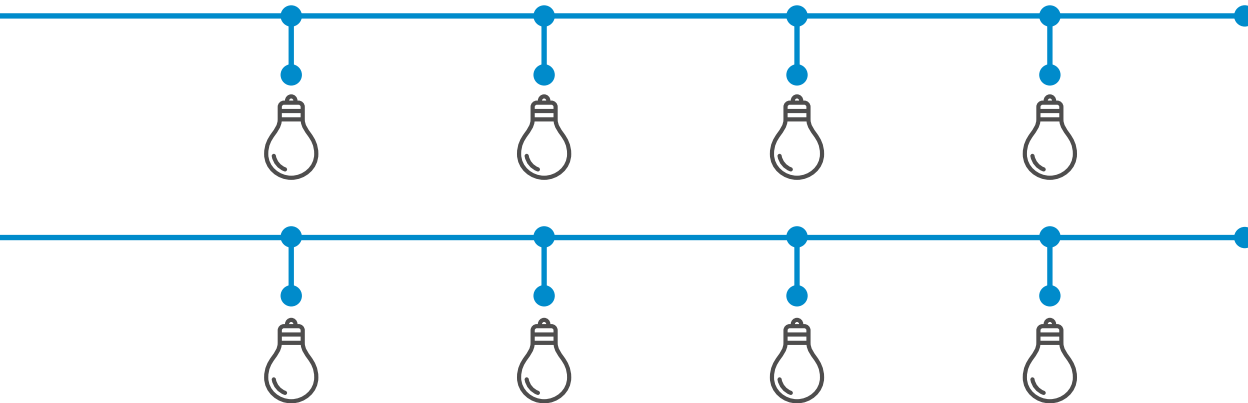

DALI control

A simple touch for the perfect scenario

To make the best use of the energy consumed by the building and to tailor the colour and feel of a space to user needs and desires requires very few items with the Carlo Gavazzi system.

Aurora and Eunica

To empower the user to change the lighting according to the activity or the mood: Eunica and Aurora are 4-gang keypads in 55x55 and 44x44 dimensions. Each push button is fully programmable. They are also available in a wireless solution.



Presence and movement sensor

To switch on the light only when it is needed, a presence sensor is a mandatory choice: if it has a light sensor like the Carlo Gavazzi's one included, nothing else is needed to obtain daylight harvesting. The sensor is available in different shapes and mounting options.



Stylish and functional remote control

The perfect mood or the perfect energy saving strategy can also be set very easily using your smart devices, your PC or the Carlo Gavazzi's SmartHub display.

Simply use your smart device

Any smart device can be turned into a remote controller to alter the colour temperature levels between 2700K and 6500K or even change the intensity levels for a particular CCT

setting. The pages of the web-app can easily be customised according to need.

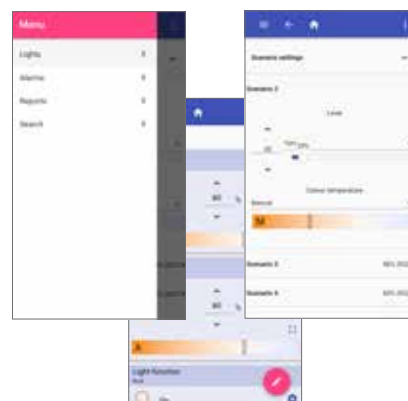

Just a finger tip

For centralized room control, the SmartHub display is the ideal solution: pages can be customised with any image or icon and any command/scenario programmed into the Sx2WEB can easily be changed with just a finger touch.

The display is available in a 4" and 7" version and the mounting is into the wall by means of its wall-box.



Everything under control

Any PC or notebook can be turned into a configurable interface to control the installation: in the same way in which pages are created for the display, they can also be customised

for any Windows PC and any display dimensions.



OUR SALES NETWORK IN EUROPE

AUSTRIA

Carlo Gavazzi GmbH
Ketzergrasse 374,
A-1230 Wien
Tel: +43 1 888 4112
Fax: +43 1 889 10 53
office@carlogavazzi.at

BELGIUM

Carlo Gavazzi NV/SA
Mechelsesteenweg 311,
B-1800 Vilvoorde
Tel: +32 2 257 4120
Fax: +32 2 257 41 25
sales@carlogavazzi.be

DENMARK

Carlo Gavazzi Handel A/S
Over Hadstenevej 40,
DK-8370 Hadsten
Tel: +45 89 60 6100
Fax: +45 86 98 15 30
handel@gavazzi.dk

FINLAND

Carlo Gavazzi OY AB
Ahventie, 4 B,
FI-02170 Espoo
Tel: +358 9 756 2000
myynti@gavazzi.fi

FRANCE

Carlo Gavazzi Sarl
Zac de Paris Nord II, 69, rue de la Belle Etoile,
F-95956 Roissy CDG Cedex
Tel: +33 1 49 38 98 60
Fax: +33 1 48 63 27 43
french.team@carlogavazzi.fr

GERMANY

Carlo Gavazzi GmbH
Pfnorstr. 10-14
D-64293 Darmstadt
Tel: +49 6151 81000
Fax: +49 6151 81 00 40
info@gavazzi.de

GREAT BRITAIN

Carlo Gavazzi UK Ltd
4.4 Frimley Business Park,
Frimley, Camberley, Surrey GU16 7SG
Tel: +44 1 276 854 110
Fax: +44 1 276 682 140
sales@carlogavazzi.co.uk

ITALY

Carlo Gavazzi SpA
Via Milano 13,
I-20020 Lainate
Tel: +39 02 931 761
Fax: +39 02 931 763 01
info@gavazziacbu.it

NETHERLANDS

Carlo Gavazzi BV
Wijkermeerweg 23,
NL-1948 NT Beverwijk
Tel: +31 251 22 9345
Fax: +31 251 22 60 55
info@carlogavazzi.nl

NORWAY

Carlo Gavazzi AS
Melkeveien 13,
N-3919 Porsgrunn
Tel: +47 35 93 0800
Fax: +47 35 93 08 01
post@gavazzi.no

PORTUGAL

Carlo Gavazzi Lda
Rua dos Jerónimos 38-B,
P-1400-212 Lisboa
Tel: +351 21 361 7060
Fax: +351 21 362 13 73
carlogavazzi@carlogavazzi.pt

SPAIN

Carlo Gavazzi SA
Avda. Iparraguirre, 80-82,
E-48940 Leioa (Bizkaia)
Tel: +34 94 480 4037
Fax: +34 94 431 6081
gavazzi@gavazzi.es

SWEDEN

Carlo Gavazzi AB
V:a Kyrkogatan 1,
S-652 24 Karlstad
Tel: +46 54 85 1125
Fax: +46 54 85 11 77
info@carlogavazzi.se

SWITZERLAND

Carlo Gavazzi AG
Verkauf Schweiz/Vente Suisse
Sumpfstrasse 3,
CH-6312 Steinhausen
Tel: +41 41 747 4535
Fax: +41 41 740 45 40
info@carlogavazzi.ch

OUR SALES NETWORK IN THE AMERICAS

USA

Carlo Gavazzi Inc.
750 Hastings Lane,
Buffalo Grove, IL 60089, USA
Tel: +1 847 465 6100
Fax: +1 847 465 7373
sales@carlogavazzi.com

CANADA

Carlo Gavazzi Inc.
2660 Meadowvale Boulevard,
Mississauga, ON L5N 6M6, Canada
Tel: +1 905 542 0979
Fax: +1 905 542 22 48
gavazzi@carlogavazzi.com

MEXICO

Carlo Gavazzi Mexico S.A. de C.V.
Circuito Puericultores 22, Ciudad Satelite
Naucalpan de Juárez, EDOMEX CP 53100
Tel & Fax: +52.55.5373.7042
mexicosales@carlogavazzi.com

BRAZIL

Carlo Gavazzi Automação Ltda. Av.
Francisco Matarazzo, 1752
Conj 2108 - Barra Funda - São Paulo/SP
Tel: +55 11 3052 0832
Fax: +55 11 3057 1753
info@carlogavazzi.com.br

OUR SALES NETWORK IN ASIA AND PACIFIC

SINGAPORE

Carlo Gavazzi Automation Singapore Pte. Ltd.
61 Tai Seng Avenue #05-06
Print Media Hub @ Paya Lebar iPark
Singapore 534167
Tel: +65 67 466 990
Fax: +65 67 461 980
info@carlogavazzi.com.sg

MALAYSIA

Carlo Gavazzi Automation (M) SDN. BHD.
D12-06-G, Block D12,
Pusat Perdagangan Dana 1,
Jalan PJU 1A/46, 47301 Petaling Jaya,
Selangor, Malaysia.
Tel: +60 3 7842 7299
Fax: +60 3 7842 7399
sales@gavazzi-asia.com

CHINA

Carlo Gavazzi Automation
(China) Co. Ltd.
Unit 2308, 23/F.,
News Building, Block 1, 1002
Middle Shennan Zhong Road,
Shenzhen, China
Tel: +86 755 83699500
Fax: +86 755 83699300
sales@carlogavazzi.cn

HONG KONG

Carlo Gavazzi Automation
Hong Kong Ltd.
Unit 3 12/F Crown Industrial Bldg.,
106 How Ming St., Kwun Tong,
Kowloon, Hong Kong
Tel: +852 23041228
Fax: +852 23443689

OUR COMPETENCE CENTRES AND PRODUCTION SITES

DENMARK

Carlo Gavazzi Industri A/S
Hadsten

MALTA

Carlo Gavazzi Ltd
Zejtun

ITALY

Carlo Gavazzi Controls SpA
Belluno

LITHUANIA

Uab Carlo Gavazzi Industri Kaunas
Kaunas

CHINA

Carlo Gavazzi Automation (Kunshan) Co., Ltd.
Kunshan

HEADQUARTERS

Carlo Gavazzi Automation SpA
Via Milano, 13
I-20020 - Lainate (MI) - ITALY
Tel: +39 02 931 761
info@gavazziautomation.com

CARLO GAVAZZI
Automation Components

Energy to Components!

www.gavazziautomation.com

